

The Ultimate Design Guide

Volume 2: System Specifications

BBR VT CONA CMX

Strand Post-tensioning Systems



A Global Network of Experts
www.bbrnetwork.com



BBR A Global Network of Experts www.bbrnetwork.com

The BBR Network is recognized as the leading group of specialized engineering contractors in the field of post-tensioning, stay cable and related construction engineering. The innovation and technical excellence, brought together in 1944 by its three Swiss founders – Antonio Brandestini, Max Birkenmaier and Mirko Robin Ros – continues, 70 years later, in that same ethos and enterprising style.

From its Technical Headquarters and Business Development Centre in Switzerland, the BBR Network reaches out around the globe and has at its disposal some of the most talented engineers and technicians, as well as the very latest internationally approved technology.

THE GLOBAL BBR NETWORK

Within the Global BBR Network, established traditions and strong local roots are combined with the latest thinking and leading edge technology. BBR grants each local BBR Network Member access to the latest technical knowledge and resources – and facilitates the exchange of information on a broad scale and within international partnering alliances. Such global alliances and co-operations create local competitive advantages in dealing with, for example, efficient tendering, availability of specialists and specialized equipment or transfer of technical know-how.

ACTIVITIES OF THE NETWORK

All BBR Network Members are well-respected within their local business communities and have built strong connections in their respective regions. They are all structured differently to suit the local market and offer a variety of construction services, in addition to the traditional core business of post-tensioning.

BBR TECHNOLOGIES & BRANDS

BBR technologies have been applied to a vast array of different structures – such as bridges, buildings, cryogenic LNG tanks, dams, marine structures, nuclear power stations, retaining walls, tanks, silos, towers, tunnels, wastewater treatment plants, water reservoirs and wind farms. The BBR® brands and trademarks – CONA®, BBRV®, HiAm®, HiEx, DINA®, SWIF®, BBR E-Trace and CONNECT® – are recognized worldwide.

The BBR Network has a track record of excellence and innovative approaches – with thousands of structures built using BBR technologies. While BBR's history goes back over 70 years, the BBR Network is focused on constructing the future – with professionalism, innovation and the very latest technology.

BBRVT International Ltd is the Technical Headquarters and Business Development Centre of the BBR Network located in Switzerland. The shareholders of BBR VT International Ltd are: BBR Holding Ltd (Switzerland), a subsidiary of the Tectus Group (Switzerland); KB Spennteknikk AS (Norway), BBR Polska z o.o. (Poland) and KB Vorspann-Technik GmbH (Germany) – all three are members of KB Group (Norway); BBR Pretensados y Tecnicas Especiales PTE, S.L. (Spain), a member of the FCC Group (Spain).

Strong, fast, green

Within the BBR Network, we have a long history of innovation founded on listening to what our customers want and then going the extra mile to deliver it – the BBRVT CONA CMX range of post-tensioning is our response to current needs. This brochure is the ultimate 'must-have' guide for designers and engineers, as it contains details of the complete range of BBRVT CONA CMX technology.

You will see that we've focused on creating a sound solution which offers benefits for all types of construction applications and to all stakeholders. We have combined the requirement for strength and reliability with a completely flexible and environmentally responsible approach. When this comes together with the expertise and professionalism of the BBR Network to advise on and install post-tensioning systems, it is an unbeatable combination – and we are sure you will agree that there's no finer solution on the market!

Our new technology allows more freedom than ever before for architectural and design creativity and it can save valuable program time, while reducing impact on budgets and the environment. But there's even more, we've had our systems independently tested – and have even gone beyond the requirements of international norms. Our CONA CMX range has European Technical Approval (ETA) and, thus, bears the CE marking.

You may have guessed by now that we are very proud of our BBRVT CONA CMX range of post-tensioning technology – and we believe that you will be too!

How to use this brochure



Check ETA

CONA CMX systems have European Technical Approval (ETA) which can be downloaded on our website www.bbrnetwork.com

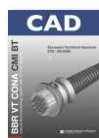

Check latest CAD files

CAD files of each system are on our website, visit the Download section.

2	BBRVT CONA CMX
3	Use and definition of CONA CMX post-tensioning kit
7	Materials
11	Corrosion protection
14	Design and detailing
24	Annex – CONA CMI internal
33	Annex – CONA CME external
40	Annex – CONA CMF flat
42	Annex – CONA CMM monostrand
44	Annex – CONA CMB band
46	Annex – Notations, units and reference documents
48	Annex – Additional post-tensioning systems

BBR VT CONA CMX

CE marked state-of-the-art post-tensioning kits

The BBR Network offers a complete range of post-tensioning systems, covering all possible applications in structural and civil engineering. With the introduction of CE marking for all construction products in Europe, European Technical Approval (ETA), Euronorms (EN) and Eurocodes, we developed and launched the BBR VT CONA CMX post-tensioning range – the post-tensioning system for the 21st century – which is now used worldwide by the BBR Network.

The modular BBR VT CONA CMX post-tensioning range is comprised of five main systems:

- ◆ **BBR VT CONA CMI**
– internal post-tensioning system
- ◆ **BBR VT CONA CME**
– external post-tensioning system
- ◆ **BBR VT CONA CMB**
– band post-tensioning system
- ◆ **BBR VT CONA CMF**
– flat anchorage post-tensioning system
- ◆ **BBR VT CONA CMM**
– monostrand post-tensioning system

The main benefits of the BBRVT CONA CMX series are:

- ◆ **modular system**
- ◆ **most compact and lightest anchorage system**
- ◆ **full stressing at lowest concrete strength**
- ◆ **widest range of standard tendons – ranging from 173 kN to over 20,000 kN characteristic ultimate resistance**
- ◆ **most comprehensive range of systems and tendon sizes**

Its modular design means that a CONA CMX post-tensioning kit can easily be configured to match very special requirements and therefore only the most commonly used configurations are described in this brochure. Please contact the BBR Headquarters or your local BBR Network representative to discuss your specific needs.

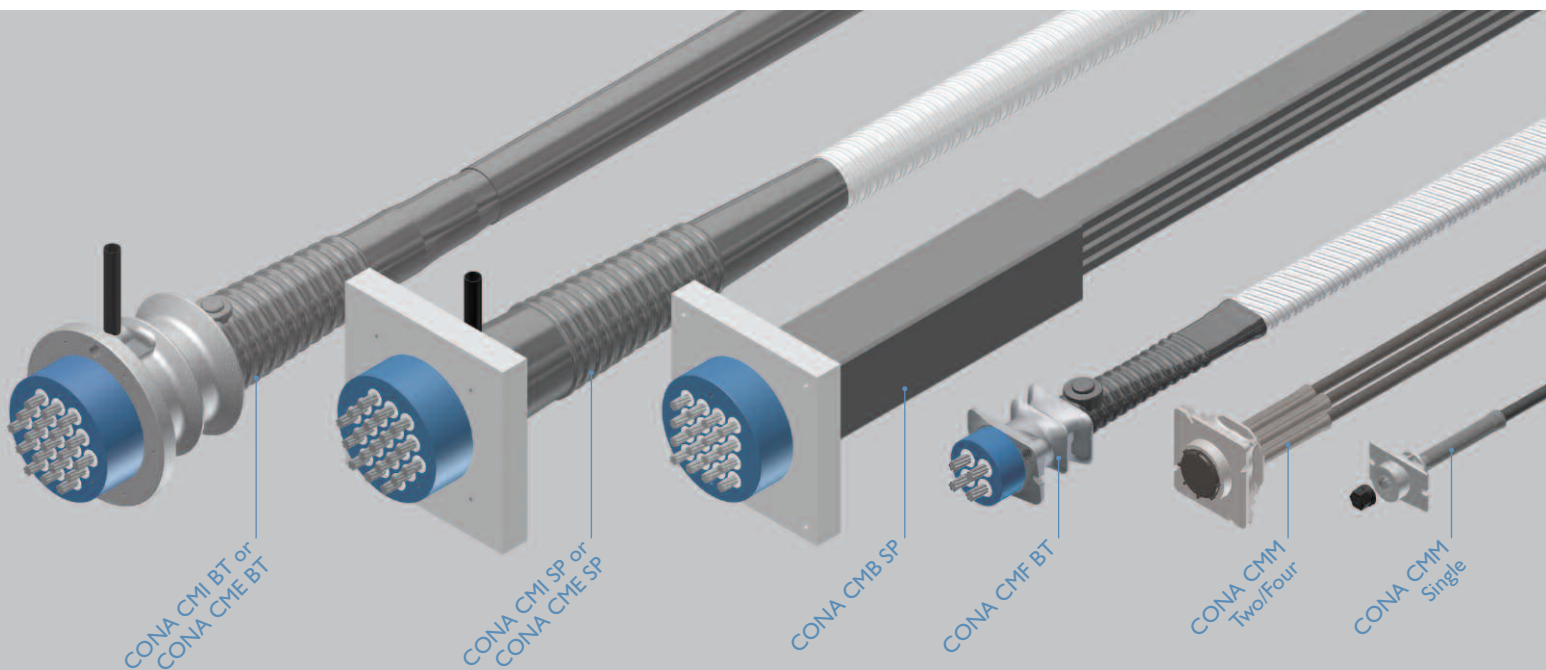

Use and definition of CONA CMX post-tensioning kit

Intended use

The CONA CMX strand post-tensioning kits are intended for the post-tensioning of structures. Use categories according to type of tendon and material of structure:

Intended use:

- ◆ Internal bonded tendon
- ◆ Internal unbonded tendon
- ◆ External tendon

Optional use for special applications:

- ◆ Restressable tendons
- ◆ Exchangeable tendons
- ◆ Electrically isolated tendons
- ◆ Tendons for cryogenic applications
- ◆ Tendons for nuclear applications

Terminology

A typical post-tensioning kit comprises all elements that make up the complete tendon consisting of a fixed (passive) anchorage and a stressing (active) anchorage, coupled optionally with a fixed or movable coupler, and prestressing steel strands.

An anchorage (type fixed or stressing) transfers the prestressing force at both ends of a structural member to the concrete and consists of:

- ◆ Anchor head
- ◆ Wedges
- ◆ Load transfer element (bearing trumplate or square plate)
- ◆ Trumpet
- ◆ Protection cap
- ◆ Helix and additional reinforcement
- ◆ Corrosion protection

CONA CMX systems can be coupled to transmit the post-tensioning force from one construction stage to the other. A coupler (single plane or sleeve type) works in a similar way to an anchorage. It consists of:

- ◆ Coupler heads
- ◆ Wedges
- ◆ Load transfer element, if fixed (bearing trumplate or square plate)
- ◆ Trumpet
- ◆ Helix and additional reinforcement
- ◆ Corrosion protection

The tendon transmits the prestressing force from one anchorage or coupler to the other and comprise of:

- ◆ Seven-wire prestressing steel strands
- ◆ Plastic or steel duct
- ◆ Special or common filling material (corrosion protection)

Table 1: CONA CMX intended use

	Internal		External
	Bonded	Unbonded	Unbonded
CONA CMI	●	●	
CONA CME			●
CONA CMB			●
CONA CMF	●	●	△
CONA CMM (Single)	●	●	△
CONA CMM (Two/Four)		●	△

● Standard △ Subject to the regulations in force at the place of use

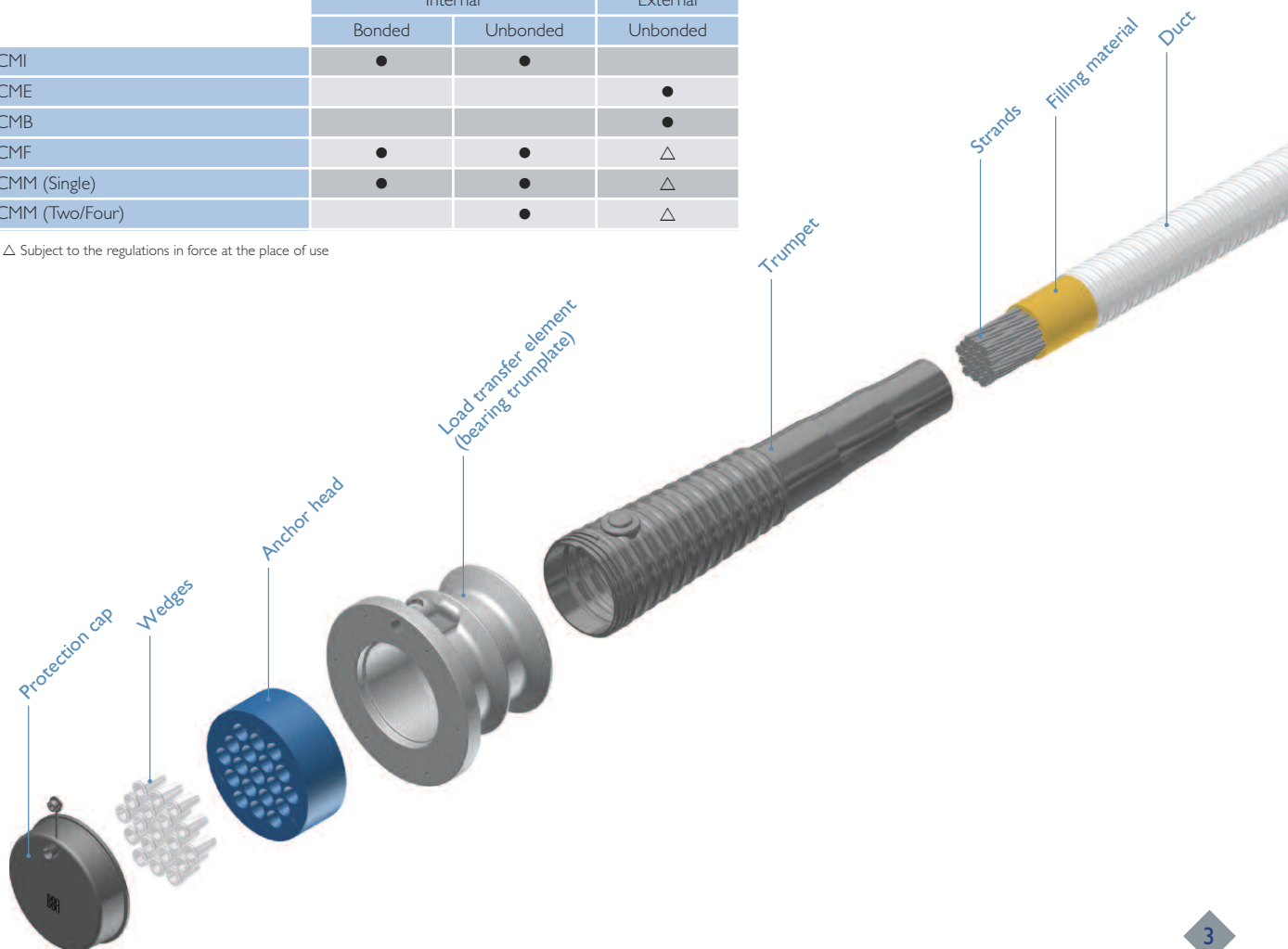

Table 2: Product range

BBR VT CONA CMX ³⁾							CMI				CME				CMB	CMF		CMM			
							BT	SP	BT	SP	BT	SP	BT	SP	SP	BT	BT	Single	Two/Four		
Type of strands																					
Type		05		06		06C	05	06	05	06	06	06C	05	06	06	06C	06	06C			
A _p	mm ²	93	100	140	150	165	93-100	140-150	93-100	140-150	140-150	165	93-100	140-150	140-150	165	140-150	165			
d	mm	12,5	12,9	15,3	15,7	15,2															
f _{pk}	MPa	1860		1860		1820															
Strands																					
Characteristic ultimate resistance of tendon (F _{pk}) [kN]							Size/Application														
01	173	186	260	279	300		●	●	●	●	●	●	●	●	●	●	●	●			
02	346	372	520	558	600	●	●	●	●	●	●	●	●	●	●	●	●	●			
03	519	558	780	837	900	●	●	●	●	●	●	●	●	●	●	●	●	●			
04	692	744	1,040	1,116	1,200	●	●	●	●	●	●	●	●	●	●	●	●	●			
05	865	930	1,300	1,395	1,500		●	●	●	●	●	●									
06	1,038	1,116	1,560	1,674	1,800		●	●	●	●	●	●									
07	1,211	1,302	1,820	1,953	2,100	●	●	●	●	●	●	●									
08	1,384	1,488	2,080	2,232	2,400	●	●	●	●	●	●	●									
09	1,557	1,674	2,340	2,511	2,700		●	●	●	●	●	●									
12	2,076	2,232	3,120	3,348	3,600	●	●	●	●	●	●	●	●								
13	2,249	2,418	3,380	3,627	3,900	●	●	●	●	●	●	●									
15	2,595	2,790	3,900	4,185	4,500		●	●	●	●	●	●									
16	2,768	2,976	4,160	4,464	4,800		●	●	●	●	●	●	●								
19	3,287	3,534	4,940	5,301	5,700	●	●	●	●	●	●	●									
22	3,806	4,092	5,720	6,138	6,600	●	●	●	●	●	●	●									
24	4,152	4,464	6,240	6,696	7,200	●	●	●	●	●	●	●									
25	4,325	4,650	6,500	6,975	7,500		●	●	●	●	●	●									
27	4,671	5,022	7,020	7,533	8,100		●	●	●	●	●	●									
31	5,363	5,766	8,060	8,649	9,300	●	●	●	●	●	●	●									
37	6,401	6,882	9,620	10,323	11,100			●	●	●	●	●									
42	7,266	7,812	10,920	11,718	12,600			●	●	●	●	●									
43	7,439	7,998	11,180	11,997	12,900			●	●	●	●	●									
48	8,304	8,928	12,480	13,392	14,400			●	●	●	●	●									
55	9,515	10,230	14,300	15,345	16,500			●	●	●	●	●									
61	10,553	11,346	15,860	17,019	18,300			●	●	●	●	●									
69	11,937	12,834	17,940	19,251	20,700			●	●	●	●	●									
73	12,629	13,578	18,980	20,367	21,900			●	●	●	●	●									
>73	On request							△			△										
Anchorage and Coupler																					
Stressing (S)		● ● ● ● ● ● ● ● ● ● ● ● ● ● ● ● ● ● ● ●																			
Fixed (F)		● ● ● ● ● ● ● ● ● ● ● ● ● ● ● ● ● ● ● ●																			
Coupler		Type K (02-31 strands)																			
		Type H (01-73 strands)																			
Anchorage (A)		● ● ● ● ● ● ● ● ● ● ● ● ● ● ● ● ● ● ● ●																			
Monolithic (-)																					
Bearing trumplate (BT)		● ● ● ● ● ● ● ● ● ● ● ● ● ● ● ● ● ● ● ●																			
Square plate (SP)		● ● ● ● ● ● ● ● ● ● ● ● ● ● ● ● ● ● ● ●																			
Cast in bond (-)		△ △ △ △ ● ● ● ● ● ● ● ● ● ● ● ● ● ● ●																			
Corrosion protection																					
Duct	Steel	Corrugated	● ● ● ● ● ● ● ● ● ● ● ● ● ● ● ● ● ● ● ●																		
		Smooth	▲ ▲ ▲ ▲ ● ● ● ● ● ● ● ● ● ● ● ● ● ● ●																		
	Plastic	Corrugated	● ● ● ● ● ● ● ● ● ● ● ● ● ● ● ● ● ● ● ●																		
		Smooth	▲ ▲ ▲ ▲ ● ● ● ● ● ● ● ● ● ● ● ● ● ● ●																		
Monostrand ¹⁾		△ △ △ △ △ △ △ △ ● ● ● ● ● ● ● ● ● ● ● ● ● ● ●																			
Filler	Grout	● ● ● ● ● ● ● ● ● ● ● ● ● ● ● ● ● ● ● ●																			
	Grease	● ● ● ● ● ● ● ● ● ● ● ● ● ● ● ● ● ● ● ●																			
	Wax	● ● ● ● ● ● ● ● ● ● ● ● ● ● ● ● ● ● ● ●																			

● Standard ▲ Standard in unbonded applications. Subject to the regulations in force at the place of use in bonded applications △ Subject to the regulations in force at the place of use
 1) Monostrand with factory provided HDPE sheathing and wax/grease 2) Special band sheathing 3) Please check availability of product range with your nearest BBR representative

Seventh & Eighth LNG Tanks, Barcelona, Spain
– BBRVT CONA CMI internal



Tesco Woolwich Central development, London, UK
– BBRVT CONA CMF flat



The Zagreb Arena, Croatia – BBRVT CONA CMI internal



Kulmbachtal Bridge, Germany
– BBRVT CONA CMB band



Las Palmas Court Building, Canary Islands, Spain
– BBRVT CONA CMM monostrand

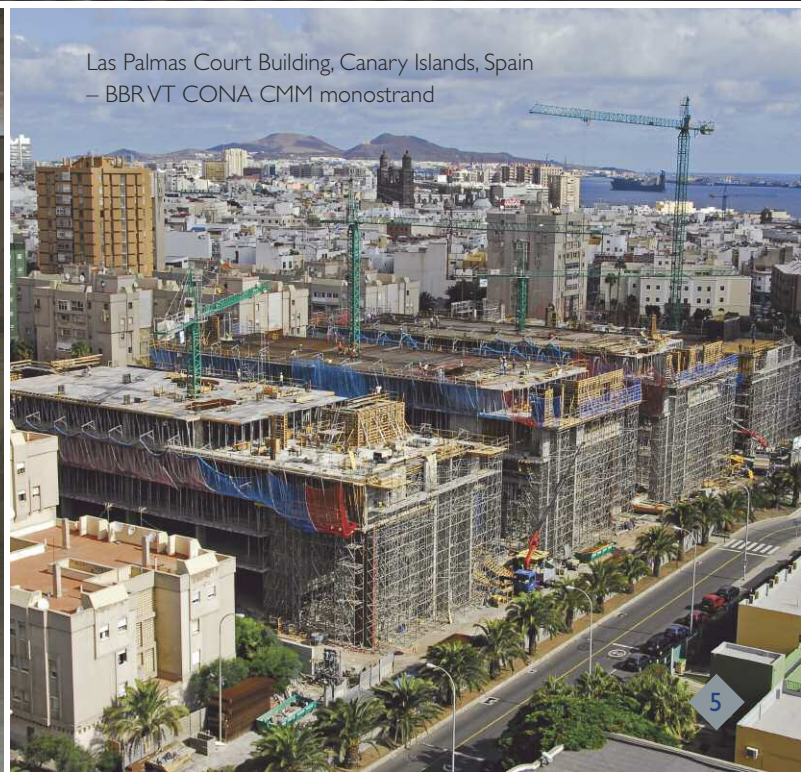

How to specify a CONA CMX system

Main system designation

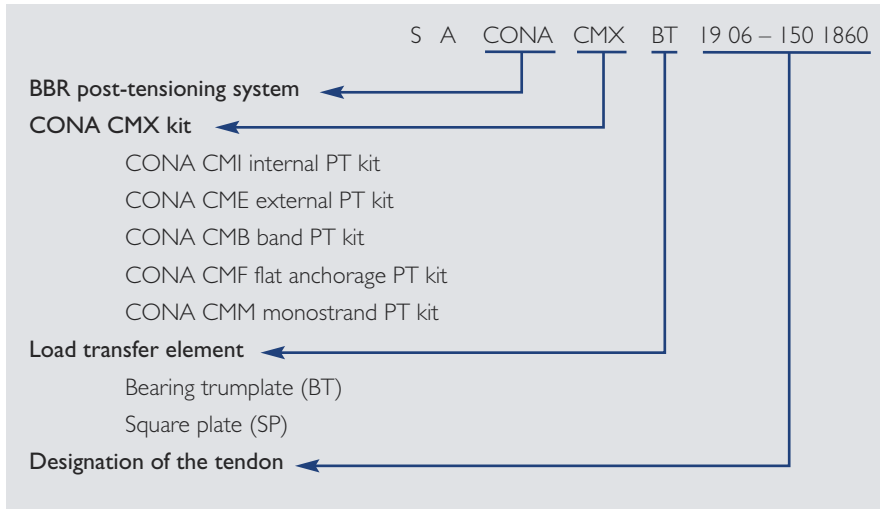

End anchorage designation

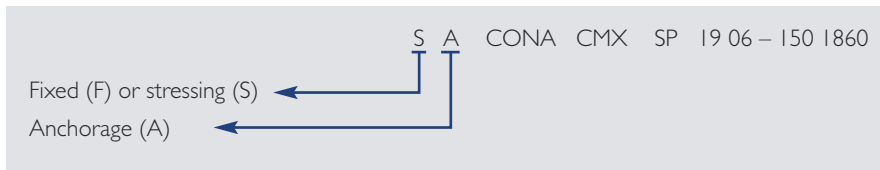

Coupler designation

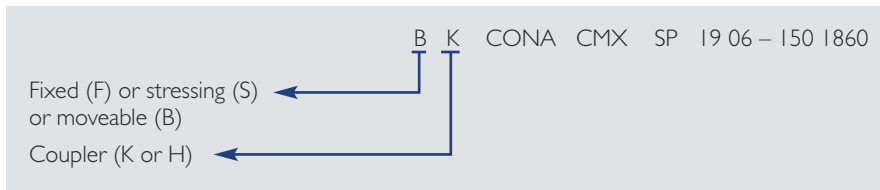

Designation of the tendon

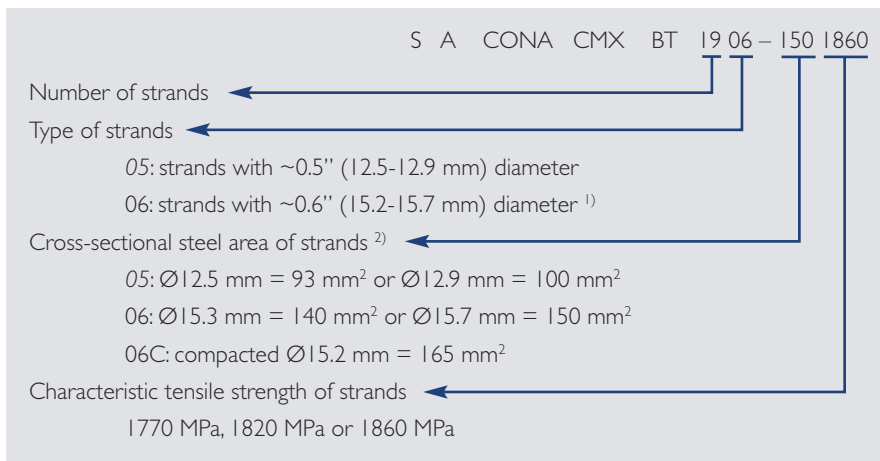

1) 06 is also used here to designate 06C compacted strands
 2) see Table 3 for strand specifications

Materials

Seven-wire prestressing strands

Seven-wire strands comprise a central wire, normally identified as 'king wire', and an external crown of six wires which are twisted around the king wire. Strands with a characteristic tensile strength equal to 1,860 MPa are normally used – however steel strands with a lower characteristic strength, 1,770 MPa or 1,820 MPa, may also be used. The characteristic values of the standard strands are shown in Table 3.

Other suitable strands according to standards and regulations valid at the place of use may also be used, such as for example the ones shown in Table 4.

Cross-sectional steel areas and strand type grouping (05, 06, 06C) are explained on page 6.



Table 3: Typical strand material properties to prEN 10138-3

Type of strands			05		06				06C
Characteristic tensile strength	f_{pk}	MPa	1,770	1,860	1,770	1,860	1,770	1,860	1,820
Characteristic value of maximum force	F_{pk}	kN	177	186	248	260	266	279	300
Characteristic value of 0.1% proof force	$F_{p0.1}$	kN	156	164	218	229	234	246	264
Nominal diameter	d	mm	12.9		15.3		15.7		15.2
Nominal cross-sectional area	A_p	mm ²	100		140		150		165
Mass of prestressing steel	M	kg/m	0.781		1.093		1.172		1.289
Minimum elongation at maximum force	A_{gt}	%	3.5						
Modulus of elasticity	E_p	MPa	approx. 195,000						

Greased/waxed monostrands are sheathed in the factory with a continuously extruded HDPE sheathing

External diameter of strand (incl. HDPE)	≈	mm	17	19.5	20	20
Mass of strand (incl. grease/wax and HDPE)	≈	kg/m	0.90	1.23	1.31	1.40

Table 4: Other strand material properties

Type of strands			05			06		
Characteristic tensile strength	f_{pk}	MPa	1,770	1,860	1,870	1,770	1,860	1,830
Standard	-	-	prEN 10138-3	prEN 10138-3	AS/NZS 4672	prEN 10138-3	ASTM A416	AS/NZS 4672
Characteristic value of maximum force	F_{pk}	kN	165	173	184	246	240	261
Characteristic value of 0.1% proof force	$F_{p0.1}$	kN	145	152	151	216	216	214
Nominal diameter	d	mm	12.5		12.7	15.2		15.2
Nominal cross-sectional area	A_p	mm ²	93		98.6	139	139	143
Mass of prestressing steel	M	kg/m	0.7263		0.774	1.086	1.094	1.122
Minimum elongation at maximum force	A_{gt}	%	3.5					
Modulus of elasticity	E_p	MPa	approx. 195,000					

There are two basic strand configurations:

- ◆ bare strands for bonded and unbonded applications
- ◆ monostrands with a factory-provided corrosion protection system consisting of corrosion protection grease/wax and HDPE sheathing for unbonded applications

Table 5 shows the intended use of the different type of strands applicable with the CONA CMX strand post-tensioning kits.

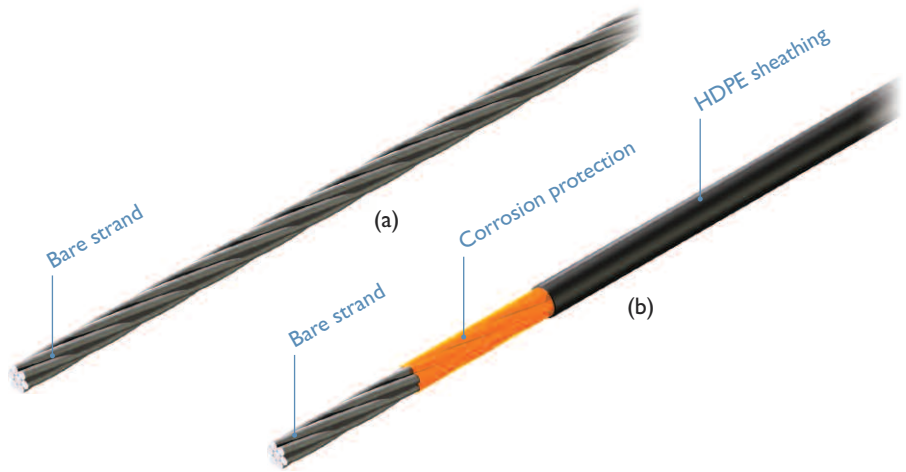

Bare strand (a) and monostrand (b)

Table 5: Intended use of prestressing strand with the CONA CMX post-tensioning kits

Type of strands	05	06		06C
Nominal cross-sectional area (mm ²)	100	140	150	165
CONA CMI	●	●	●	
CONA CME	●	●	●	
CONA CMB		●	●	●
CONA CMF	●	●	●	
CONA CMM (Single)		●	●	●
CONA CMM (Two/Four)		●	●	●

Concrete

Compressive strength of concrete in accordance with EN 206 is defined by the characteristic value f_{ck} (5% fractile of normal distribution) obtained compressive tests executed at 28 days after casting of cylindrical specimens of diameter 150 mm and height 300 mm or 150 mm cubic specimens. Compressive strength classes are denoted by the letter C followed by two numbers that indicate the cylinder and cube characteristic strength, expressed in MPa, for example C20/25.

Figure 1 shows an ideal distribution of the values of compressive strength for concrete specimens. In the figure, the curve peak coincides with the average of the compressive strength and is normally known as the mean compressive strength, f_{cm} . The characteristic compressive strength is lower than the mean compressive strength and both may typically be related with the following expression:

$$f_{ck,cylinder} \approx f_{cm,cylinder} - 8 \text{ MPa}$$

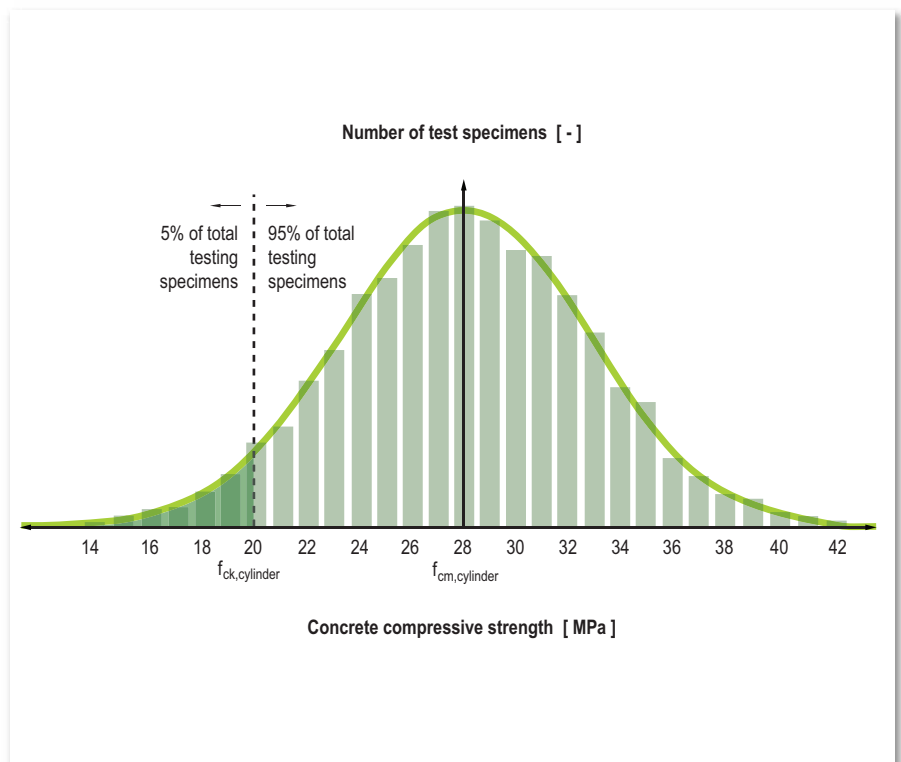

Figure 1: Generic normal distribution of concrete strength

Ducts

Ducts made of steel or plastic are installed within the structure and create the necessary conduit for the post-tensioning strand tendons to be correctly placed and aligned. Additionally, in case of internal bonded tendons, ducts must also provide adequate bond behavior between the tendon, grout and concrete. In some cases, the duct also contributes to the electrical isolation between the tendon and the structure. Historically, tendon ducts were made of thin steel strip sheaths and, over time, new technologies have seen the introduction of different duct types. A short description of available duct types is given in the following sections. Please check with your local BBR representative for availability of these ducts.

Corrugated round steel ducts

Corrugated galvanized or bare steel ducts made from steel strip sheath complying with EN 523 or equivalent standards and regulations in force at the place of use. Corrugated round steel ducts are typically used for internal CONA CMI, CONA CMF and CONA CMM Single tendons and can be made to nearly any diameter. Depending on the duct diameter, the steel strip has a typical thickness of 0.2 - 0.6 mm.



Corrugated round steel duct

BBR VT Plastic Duct (round)

Corrugated round plastic duct complying with *fib* Bulletin 7 and ETAG 013 is used for internal CONA CMI, CONA CMF and CONA CMM Single tendons. BBR VT Plastic Ducts (round) are available with nominal internal diameters (*d_i*) of 23, 50, 60, 75, 85, 100, 115 and 130 mm. This duct uses a unique material melt which permits its use for a wide temperature range, from -20 °C to +50 °C



BBR VT Plastic Duct (round)

Corrugated flat steel ducts

Flat ducts may be used for tendons with 2 to 6 strands in accordance with EN 523 or the standards and regulations in force at the place of use. Flat ducts are commonly used for internal bonded CONA CMI and CONA CMF tendons. Flat corrugated ducts are available with a wide range of dimensions.



Corrugated flat steel duct

BBR VT Plastic Duct (flat)

Corrugated flat plastic duct complying with *fib* Bulletin 7 and ETAG 013 are used for internal CONA CMI and CONA CMF tendons. BBR VT Plastic Ducts (flat) are available with the following nominal inner dimensions: 38 x 22 mm, 72 x 21 mm and 76 x 25 mm. This duct uses a unique material melt which permits its use for a wide temperature range, from -20 °C to +50 °C



BBR VT Plastic Duct (flat)

Smooth flat steel ducts

Flat smooth steel ducts may also be used if permitted at the place of use.



Smooth flat steel duct

Smooth round steel ducts

Smooth steel ducts may be used for CONA CME external tendons and for special applications, such as internal bonded loops using CONA CMI tendons. Smooth steel ducts according to EN 10255, EN 10216-1, EN 10217-1, EN 10219-1, EN 10305-5 or the standards and regulations in force at the place of use can be used. Smooth round steel ducts are available with a wide range of diameters and wall thicknesses.



Smooth round steel duct

Smooth plastic ducts

Smooth plastic ducts, made of UV resistant high density polyethylene (HDPE), complying with EN 12201 or the standards and regulations in force at the place of use are used for external CONA CME tendons. Smooth plastic ducts are typically available with the following outside dimensions (d_o), 45, 63, 90, 110, 125, 140, 160, 180, 200 mm and a wide range of wall thicknesses and pressure ratings.



Smooth round plastic duct

Additional smooth plastic sheathing

Grouped and sheathed monostrands with an additional smooth rectangular plastic sheathing are used for CONA CMB tendons. For further details on the material and dimensional properties of the sheathed band tendons, please either refer to the relevant ETA document or contact your local BBR representative.

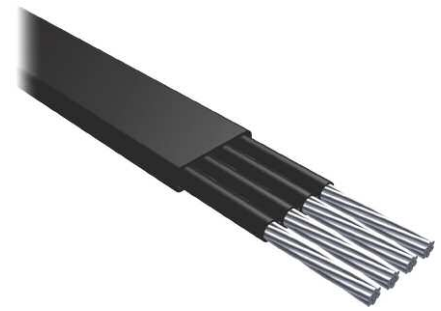

Additional smooth plastic sheathing

Table 6: Intended use of different ducts with CONA CMX post-tensioning kits

	Corrugated steel duct	Corrugated plastic duct	Smooth steel duct	Smooth plastic duct
CONA CMI	●	●	▲	▲
CONA CME			●	●
CONA CMF	●	●	▲	▲
CONA CMM (Single)	●	●	●	●

● Standard ▲ Standard in unbonded applications. Subject to the regulations in force at the place of use in bonded applications

Intended use

Table 6 shows the intended use of the different duct types within the CONA CMX post-tensioning kits.



Corrosion protection

Layers of corrosion protection

Permanent corrosion protection in the CONA CMX strand post-tensioning kits is provided by the combination of at least three redundant layers of protection in internal post-tensioning or a minimum of two layers in the case of external post-tensioning. Figure 2 below shows the different layers of corrosion protection either for bonded or unbonded post-tensioning. The different layers are explained in the following paragraphs.

Concrete cover

In internal post-tensioning tendons, dense prestressed concrete cover commonly represents the first layer of corrosion protection. Minimum concrete covers are shown in the respective standards in force at the place of use. Typical values are shown in Table 7.

In external post-tensioning tendons, concrete cover only provides protection at the location where the tendon is embedded, at the anchorages and at the deviators.

However, for external tendons inside a box girder, but still outside of the concrete, the box provides a protective environment against the direct contact of corrosive agents.

Duct

Different types of ducts (i.e. corrugated steel and plastic, or smooth steel and plastic) provide alternative degrees of corrosion protection.

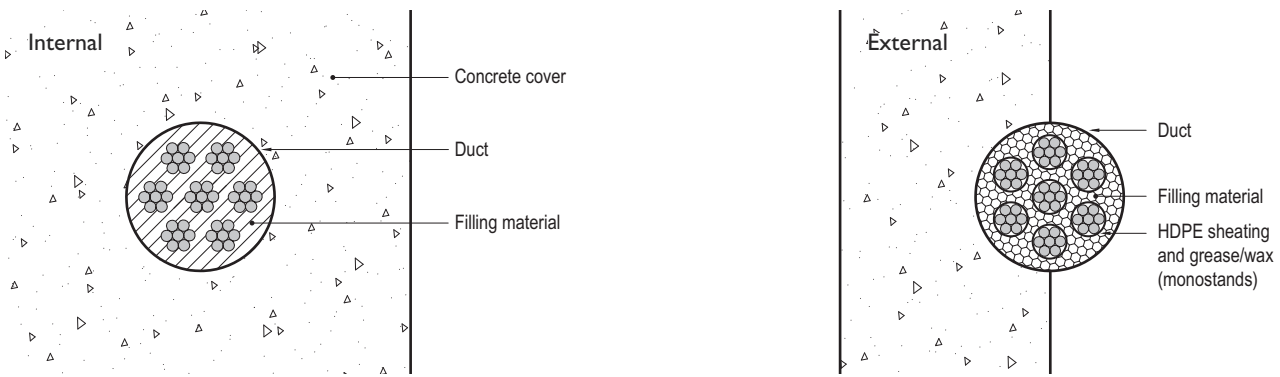

Figure 2: Different layers of corrosion protection

Table 7: Concrete cover depending on the aggressivity levels

Class designation	Description of environment	Examples where exposure classes may occur	Concrete cover (c) ¹⁾
Corrosion induced by carbonation			
XC1	Dry or permanently wet	Concrete inside buildings with very low air humidity Concrete permanently submerged in water	30 mm
XC2	Wet, rarely dry	Concrete surfaces subject to long-term water contact Many foundations	45 mm
XC3	Moderate humidity	Concrete inside buildings with moderate or high air humidity External concrete sheltered from rain	45 mm
XC4	Cyclic wet and dry	Concrete surfaces subject to water contact, not within exposure class XC2	50 mm
Corrosion induced by chlorides other than from sea water			
XD1	Moderate humidity	Concrete surfaces exposed to airborne chlorides	50 mm
XD2	Wet, rarely dry	Swimming pools Concrete exposed to industrial waters containing chlorides	55 mm
XD3	Cyclic wet and dry	Parts of bridges exposed to spray containing chlorides Pavements Car park slabs	55 mm

1) The concrete cover should be carefully checked against the specific requirements of the design standards in force at the place of use

BBR VT CONA CMX grout to latest European Standards



Grout plays a key role in the performance and durability of PT tendons. BBR VT CONA CMX grout not only provides the necessary bond between the strands and structural member, but also ensures excellent corrosion protection for the prestressing steel. Back in 2007, BBR devised and held a comprehensive grouting seminar where all BBR PT Specialists were fully trained on the latest European Standards relating to grouting requirements, procedures and test methods. Since then, BBR Network Members have adopted the new standards and are continuously educated and annually audited by the ETA Holder.

European Standards EN 447, 446 and 445

The latest European grouting standards are:

- ◆ EN 447: Basic requirements for grout for prestressing tendons
- ◆ EN 446: Grouting procedures
- ◆ EN 445: Test methods

These provide the basic requirements for the approval of cement grout in compliance with EN 1992, Eurocode 2: Design of concrete structures, prEN 13670: Execution of concrete structures and ETAG 013: Post-tensioning kits for prestressing of structures.

Testing regime

The testing regime includes three levels:

- ◆ Initial type and audit testing in accordance with EN 447
- ◆ Suitability testing for a specific project in accordance with EN 446
- ◆ Inspection during grouting works on a specific project in accordance with EN 446

The test methods are prescribed in EN 445.

Properties of grout

Testing of grout will be performed to EN 445 standard including:

- ◆ Sieve test – homogeneity
- ◆ Cone method or grout spread – fluidity
- ◆ Wick induced or inclined tube – bleeding
- ◆ Wick induced – volume change
- ◆ Broken halves of prisms – compressive strength
- ◆ Setting time
- ◆ Density

BBR VT CONA CMX grout mixtures and equipment

BBR VT CONA CMX grout mixtures are homogenous mixtures of cement, water and admixtures. Grouting equipment comprises a mixer, pump and necessary connection hoses, valves and measuring devices. Grout mixtures, properties and procedures provided by BBR PT Specialists fulfill the latest European Standards. All BBR Network Members employ qualified and trained personnel in grouting and use only prime materials, as well as leading equipment, to produce excellent grout. Furthermore, BBR VT CONA CMX grout is assessed and certified by an independent Notified Body.

Filling material

Cement grout

Cement grout is alkaline and provides a passive environment around strands. Cement grouts typically observe standards EN 445, EN 446, EN 447 or alternatively standards and regulations in force at the place of use. ETAG 013 recommends the following properties for cement grout materials:

- ◆ less than 0.3% bleeding and air void in inclined tube test
- ◆ no significant cracking visible to the naked eye in inclined test
- ◆ less than 10% sedimentation expressed as variation of density
- ◆ less than 0.3% wick-induced bleeding

Grease

Grease according to ETAG 013 or the equivalent standards and regulations in force at the place of use may be used as filling material for unbonded applications. ETAG 013 recommends amongst others the following properties for grease material:

- ◆ dropping point has to be higher than 150 °C
- ◆ after 72 hours at 40 °C less than 2.5% oil separation and after 7 days at 40 °C less than 4.5% oil separation
- ◆ no corrosion after 168 hours at 35 °C

Wax

Wax according to ETAG 013 or the equivalent standards and regulations in force at the place of use may be used as filling material for unbonded applications. ETAG 013 recommends amongst others the following properties for grease material:

- ◆ congealing point higher than 65 °C
- ◆ no cracks at penetration at 20 °C
- ◆ less than 0.5% bleeding at 40 °C

Circulating dry air

Actively circulating dry air allows for corrosion protection of the tendons provided that a permanent monitoring of the drying and circulating system is in place. This is, in general, only applicable to structures of particular importance. The respective standards and regulations in force at the place of use must be observed.

Strand sheathing

In unbonded post-tensioning with monostrands, the monostrands are individually and externally sheathed in the factory with an extruded HDPE sheathing with a thickness of at least 1.0 mm, see Figure 2. The actual thickness of the sheathing must be in accordance with the standards and regulations in force at the place of use. The recommended specifications and properties of strand sheathing according to European standards are, amongst others:

- ◆ minimum 1.0 mm thickness of sheathing
- ◆ at least 18 MPa tensile strength and at least 450% elongation at 23 °C
- ◆ no visual damage, no bubbles and no visible traces of filling material on the surface of the sheathing
- ◆ no cracking after 72 hours in a tensioactive liquid at 50 °C
- ◆ variation of tensile strength and elongation at 23 °C after conditioning for 3 days at 100 °C less than 25%
- ◆ less than 60 N/m friction between sheathing and strand
- ◆ no water leaking through specimen

Combination of corrosion protection layers

There are many ways to combine different layers of corrosion protection. Table 8 is the guideline for the different combinations. Starting from the left side of the table, every successive column provides choices for the respective layers. In the box on the right of each layer, the value of its corrosion protection layer is noted. These values are summed up by working through the table from left to right. As a guide and an overview, the accumulated layers of corrosion protection are listed in the far right column.

For example, the highest possible corrosion protection is reached by choosing the following:

Internal tendon → unbonded → monostrand (2) → plastic duct (1+) → grout (1) → concrete cover (1): 2 + 1+ + 1 + 1 = 5+

The lowest corrosion protection is provided by the following combination:

External tendon → bare strand (0) → steel duct (1) → grout, grease or wax (1) → no concrete cover (0): 0 + 1 + 1 + 0 = 2

Table 8: Corrosion protection layers

Application		Strand		Duct		Duct Filler		Concrete		Layers
internal	bonded	bare	0	steel	1	grout	1	cover	1	3
				plastic	1+					3+
	unbonded	bare	0	steel	1	grease / wax	1	cover	1	3
				plastic	1+					3+
		monostrand ¹⁾	2	none	0	none	0			3
				steel	1	grease / wax	1			5
				plastic	1+					5+
				steel	1	grout	1			5
plastic	1+	5+								
external	bare	0	steel	1	grout	1	none	0	2	
			plastic	1+					2+	
	bare	0	steel	1	grease / wax	1			2	
			plastic	1+					2+	
	monostrand ¹⁾	2	none	0	none	0	2			
			steel	1	grease / wax	1	4			
			plastic	1+			4+			
			steel	1	grout	1	4			
			plastic	1+			4+			

1) Monostrands have two layers of protection (plastic sheathing and wax/grease)

Design and detailing

Prestressing forces

Although it depends on the standard used, it is widely accepted that the yield point is defined as the point of an irreversible plastic strain of 0.1%. In this case, the stress at the yield point is identified with $f_{p0,1}$. As shown in Figure 3, the limit of proportionality, f_{pp} , is lower and is usually determined as the stress with an irreversible plastic strain of 0.01%. Also shown in the figure are the maximum overstressing force, $0.95 \cdot f_{p0,1}$, and the maximum prestressing force in terms of the yield stress, $0.9 \cdot f_{p0,1}$, and in terms of the maximum characteristic tensile strength, $0.8 \cdot f_{pk}$ according to the Eurocodes. Prestressing forces may depend on regulations in force at place of use.

Table 9: Typical strand characteristic and yield strengths

	MPa		
f_{pk}	1,770	1,820	1,860
$f_{p0,1}$	≈1,560	≈1,600	≈1,640

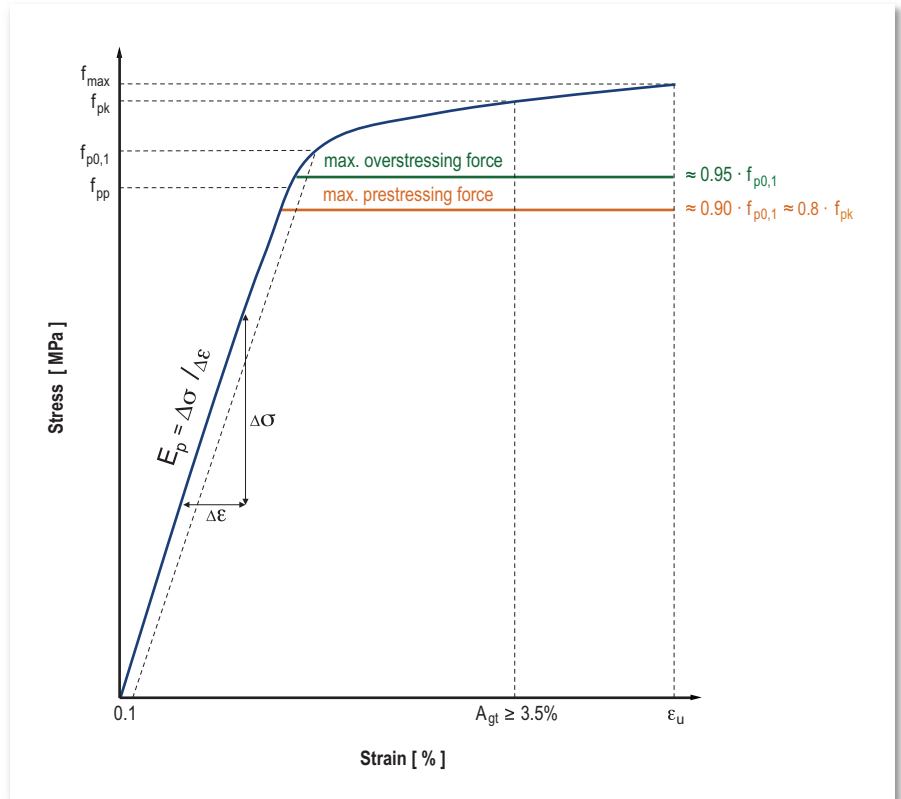

Figure 3: Stress-strain diagram of prestressing steel and relevant stress levels

The following tables show the maximum prestressing force, the maximum overstressing force and typical prestressing forces according to various standards, for different strand and tendon sizes.

Forces for strands with a tensile strength equal to 1,770 MPa might be obtained from the values in Table 10 and 11 and reduced by the factor $f_R = 0.952$.

$$F_{p0,1-1770} = F_{p0,1-1860} \cdot f_R$$

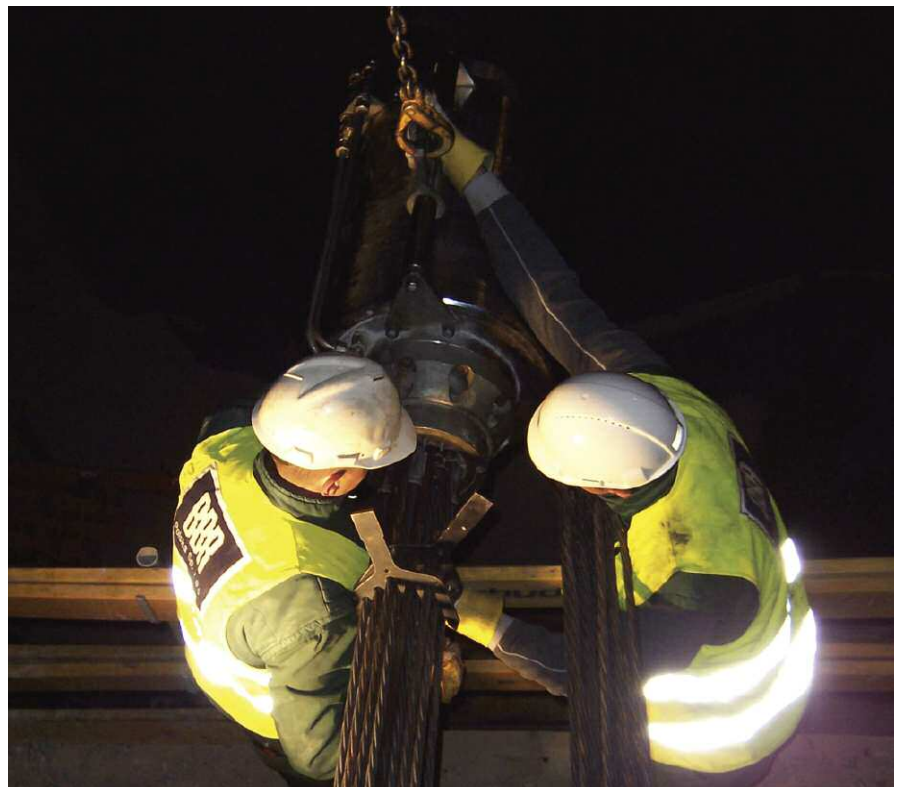

Table 10: Prestressing forces for strand 05-100 1860

	Max. prestressing forces		Max. prestressing force	Max. overstressing force	Characteristic value of max. force
	SIA	DIN	EN		
	Swiss Standards	German Standards	European Standards		
	$0.70 \cdot F_{pk} \approx$ $0.80 \cdot F_{p0,1}$	$0.85 \cdot F_{p0,1} \approx$ $0.75 \cdot F_{pk}$	$0.9 \cdot F_{p0,1} \approx$ $0.80 \cdot F_{pk}$	$0.95 \cdot F_{p0,1} \approx$ $0.85 \cdot F_{pk}$	
n 05 ¹⁾ Number of strands	kN				
01 05	130	140	148	156	186
02 05	260	279	295	312	372
03 05	391	418	443	467	558
04 05	521	558	590	623	744
07 05	911	976	1,033	1,091	1,302
12 05	1,562	1,673	1,771	1,870	2,232
19 05	2,474	2,649	2,804	2,960	3,534
31 05	4,036	4,321	4,576	4,830	5,766

Table 11: Prestressing forces for strand 06-140 1860 and 06-150 1860

Designation	Max. prestressing force				Max. prestressing force	Max. overstressing force	Characteristic value of max. force			
	SIA		DIN		EN					
	$0.70 \cdot F_{pk} \approx$ $0.80 \cdot F_{p0,1}$		$0.85 \cdot F_{p0,1} \approx$ $0.75 \cdot F_{pk}$		$0.9 \cdot F_{p0,1} \approx$ $0.80 \cdot F_{pk}$		$0.95 \cdot F_{p0,1} \approx$ $0.85 \cdot F_{pk}$		F_{pk}	
	n06-140	n06-150	n06-140	n06-150	n06-140	n06-150	n06-140	n06-150	n06-140	n06-150
n 06 ¹⁾ Number of strands	kN									
01 06	182	195	195	209	206	221	218	234	260	279
02 06	364	391	389	418	412	443	435	467	520	558
03 06	546	586	584	627	618	664	653	701	780	837
04 06	728	781	779	836	824	886	870	935	1,040	1,116
05 06	910	977	973	1,046	1,031	1,107	1,088	1,169	1,300	1,395
06 06	1,092	1,172	1,168	1,255	1,237	1,328	1,305	1,402	1,560	1,674
07 06	1,274	1,367	1,363	1,464	1,443	1,550	1,523	1,636	1,820	1,953
08 06	1,456	1,562	1,557	1,673	1,649	1,771	1,740	1,870	2,080	2,232
09 06	1,638	1,758	1,752	1,882	1,855	1,993	1,958	2,103	2,340	2,511
12 06	2,184	2,344	2,336	2,509	2,473	2,657	2,611	2,804	3,120	3,348
13 06	2,366	2,539	2,530	2,718	2,679	2,878	2,828	3,038	3,380	3,627
15 06	2,730	2,930	2,920	3,137	3,092	3,321	3,263	3,506	3,900	4,185
16 06	2,912	3,125	3,114	3,346	3,298	3,542	3,481	3,739	4,160	4,464
19 06	3,458	3,711	3,698	3,973	3,916	4,207	4,133	4,440	4,940	5,301
22 06	4,004	4,297	4,282	4,600	4,534	4,871	4,786	5,141	5,720	6,138
24 06	4,368	4,687	4,672	5,018	4,946	5,314	5,221	5,609	6,240	6,696
25 06	4,550	4,883	4,866	5,228	5,153	5,535	5,439	5,843	6,500	6,975
27 06	4,914	5,273	5,256	5,646	5,565	5,978	5,874	6,310	7,020	7,533
31 06	5,642	6,054	6,034	6,482	6,389	6,863	6,744	7,245	8,060	8,649
37 06	6,734	7,226	7,202	7,737	7,626	8,192	8,049	8,647	9,620	10,323
42 06	7,644	8,203	8,175	8,782	8,656	9,299	9,137	9,815	10,920	11,718
43 06	7,826	8,398	8,370	8,991	8,862	9,520	9,355	10,049	11,180	11,997
48 06	8,736	9,374	9,343	10,037	9,893	10,627	10,442	11,218	12,480	13,392
55 06	10,010	10,742	10,706	11,501	11,336	12,177	11,965	12,854	14,300	15,345
61 06	11,102	11,913	11,874	12,755	12,572	13,505	13,271	14,256	15,860	17,019
69 06	12,558	13,476	13,431	14,428	14,221	15,277	15,011	16,125	17,940	19,251
73 06	13,286	14,257	14,209	15,264	15,045	16,162	15,882	17,060	18,980	20,367

1) see Table 3 for strand specification. Prestressing forces vary according to place of use.

Prestress loss

Prestress force is applied to the post-tensioning tendon from the stressing end. Due to the different types of prestress losses – instantaneous and long term – the prestress force in the tendon varies from point-to-point, as well as throughout the life of the structure.

Instantaneous losses

Instantaneous losses are mainly caused by friction between the tendon and the interior of the duct, slip at anchorages and couplers and elastic deformation of the concrete.

Overview of instantaneous losses

Figure 4 shows a conceptual overview of the instantaneous losses of a typical post-tensioned beam. The upper part of the figure shows the layout of an internal tendon. The graph in the lower part of Figure 4 shows the actual force in the tendon against the distance from the stressing end. The continuous line shows the force in the tendon where stressing is carried out from both ends. The dashed line illustrates the actual force in the tendon if stressing only from the left side.

Friction losses

The intended angular deviation of the strand and the unintentional wobble of the tendon create friction between the strands and the duct, see Figure 4. In particular; when the tendon is stressed from one end, due to the curved tendon layout, the strands will press on the inside of the curve reducing the stressing force. In addition, unintended wobble further decreases the prestressing force of the tendon. Both friction sources might be evaluated according to Coulomb's law, which leads to the following equation:

$$F_x = F_0 \cdot e^{-\mu \cdot (\alpha + k \cdot x)}$$

Where F_x is the prestressing force at a distance x along the tendon, F_0 is the prestressing force at $x = 0$ m, μ is the friction coefficient, k is the wobble coefficient, α is the sum of angular displacements over distance x irrespective of direction or sign and x is the distance along the tendon from the point where the prestressing force is equal to F_0 . The formula above is demonstrated in Figure 4.

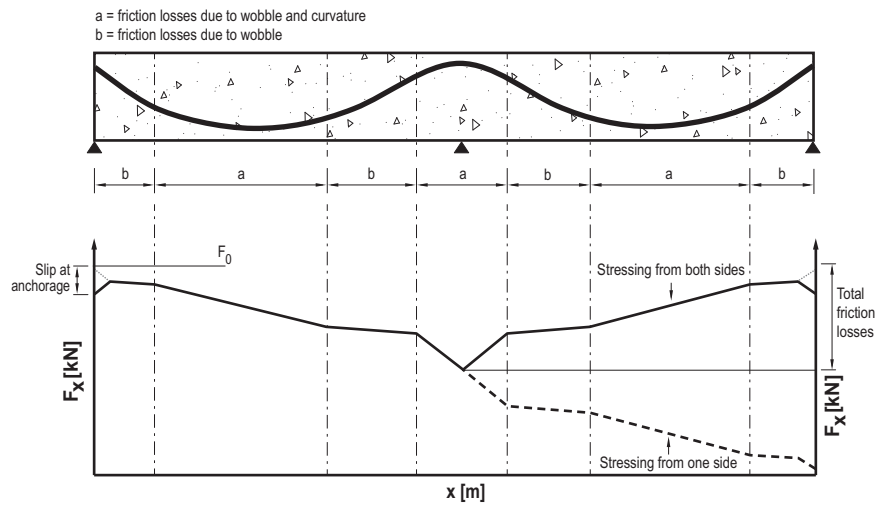

Figure 4: Concept of instantaneous losses

Table 12 shows recommended values of the friction and wobble coefficient applicable for the various CONA CMX strand post-tensioning kits.

Typically American Standards evaluate friction losses by the following similar equation:

$$F_x = F_0 \cdot e^{-(\mu \cdot \alpha + k_{as} \cdot x)}$$

Where k_{as} is an equivalent wobble coefficient which may be related to k with

$$k_{as} = \mu \cdot k$$

Slip at anchorages and couplers

During load transfer from the stressing jack to the anchorage, part of the initial load is lost due to slippage at the anchorage. This effectively results in a shortening of the strand which leads to an instantaneous loss of prestress. In general, slip at stressing and fixed anchorages and at fixed couplers is 6 mm. It should be noted that slip at movable couplers is twice this amount.

The loss of force resulting from wedge draw-in can be partially compensated by pre-seating the wedges. Wedge draw-in can be limited to 4 mm at the stressing anchorage and at the first construction stage if each wedge is pre-seated with an approximate force of 25 kN.

Elastic shortening of concrete

When the force of the tendon is transferred to the concrete, the concrete member shortens and simultaneously the post-tensioning tendon shortens by the same amount. Elastic shortening loss may be evaluated by strain compatibility, i.e. the decrease of strain in the tendon is equal to the final elastic strain in the concrete due to the load transfer: Compatibility assumption leads to the following expression:

$$\Delta F_p = F_0 \cdot \frac{E_p \cdot A_p}{E_p \cdot A_p + E_c \cdot A_c}$$

Where E_p, A_p and E_c, A_c are the modulus of elasticity and area of the prestressing steel and concrete respectively. The above expression cannot be used for tendons stretched sequentially.

Table 12: Typical friction parameters

Type of duct	Recommended values		Range of values	
	μ rad ⁻¹	k rad/m	μ rad ⁻¹	k rad/m
Corrugated steel duct	0.18	0.005	0.17 - 0.19	0.004 - 0.007
Smooth steel duct	0.18		0.16 - 0.24	
Corrugated plastic duct	0.12		0.10 - 0.14	
Smooth plastic duct	0.12		0.10 - 0.14	
Monostrand (greased/waxed)	0.06	0.009	0.05 - 0.07	0.004 - 0.010

Lower μ values can be achieved if strands are coated with water-soluble oil at time of stressing. Oil must be later washed out completely.

Long term losses

Long term losses are primarily caused by relaxation of the prestressing steel and creep and shrinkage of the concrete. Shrinkage and creep modify the length of concrete elements over time. These changes in length are followed by changes in the length of the prestressing tendons, leading to a loss of the prestress force.

Shrinkage of concrete is the volume reduction that concrete experiences when exposed to a lower relative humidity environment. Creep of concrete is the time-dependent strain which takes place after the action of constant stress over time. On the other hand, the effect called relaxation is the counterpart of creep in which, under sustained strain, the material exhibits a reduction in the stress level. Both, creep of concrete and relaxation of prestressing steel strand happen over time in post-tensioned structures.

Degree of filling, center of gravity & eccentricity

The degree of filling (f) gives the ratio of the inner area of the duct which is occupied by the prestressing steel. Accordingly, the degree of filling is defined as:

$$f = \frac{\text{cross sectional area of prestressing steel}}{\text{cross sectional area of inner diameter of duct}}$$

Thus, low degree of filling values are indicative of a relatively loose installation of the strands, see (b) in Figure 5, while higher degree of filling values are indicative of a tighter strand scenario, see (a) in Figure 5.

Typical degrees of filling values for round ducts are in the range of 0.35 to 0.50. However, in particular cases with a reduced minimum radius of curvature (for example loop tendons), smaller degree of filling values ($f \approx 0.25-0.30$) might be used to facilitate the tendon installation.

See Annex 

In the particular case of low degrees of filling, the centre of gravity of the strand bundle (G.C.S.) might lead to a considerable distance from the centre of gravity of the duct (G.C.D.). This distance or eccentricity (e), might be considered during the design stage, as it might have a noticeable effect on the overall stability of the structure.

The graphs in Figure 6 show the vertical eccentricity of post-tensioning tendons within the round duct for tendon sizes between 1 to 31 for 05 strands and 1 to 73 for 06 strands respectively.

Degrees of filling are equal to 0.25, 0.35, 0.40 and 0.45. For exact eccentricity values and common duct sizes, refer to tables in the Annex.

In the case of flat ducts with a single row of strands, see (c) in Figure 5, eccentricity may be evaluated with the following expression:

$$e = \frac{1}{2} \cdot (d_1 - d)$$

Where d_1 is the inner duct diameter and d is the diameter of the prestressing strand. However, the eccentricity of a flat duct is comparably small.

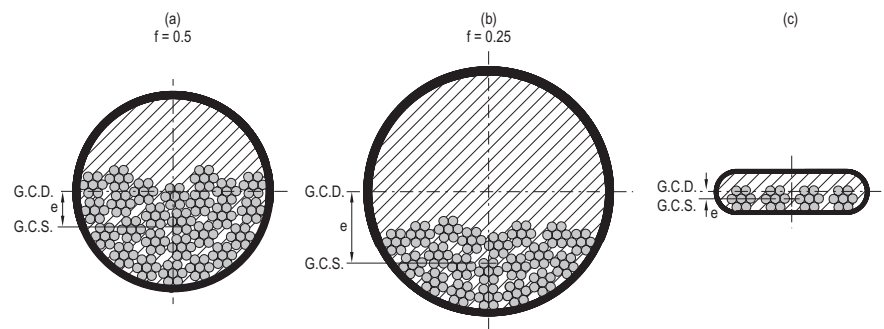

Figure 5: Center of gravity by high (a) and low (b) degree of filling of round ducts and flat duct (c)

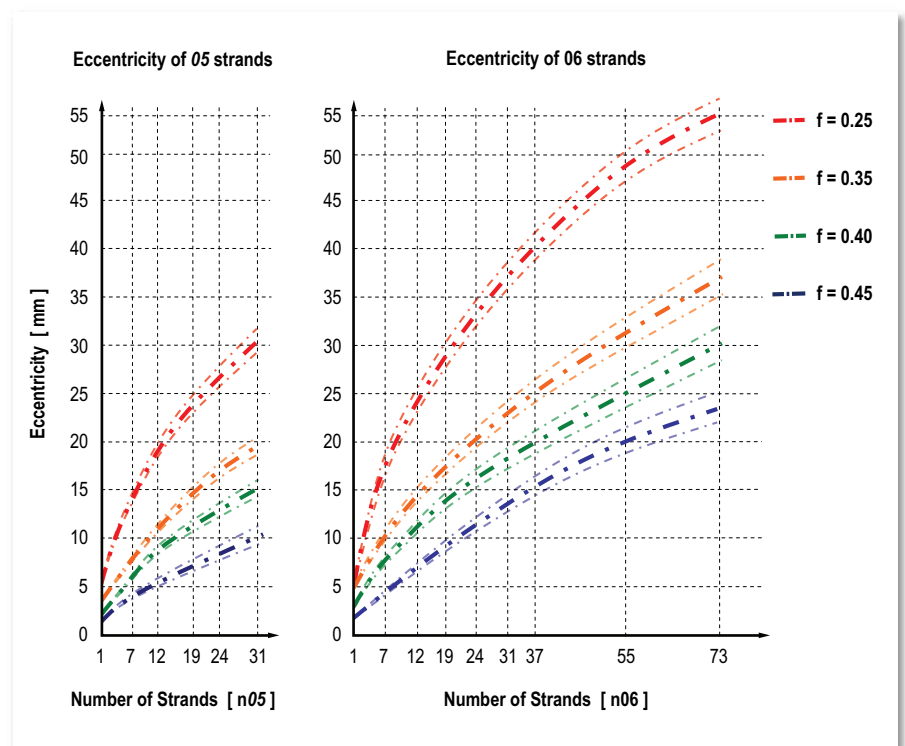

Figure 6: Eccentricity of 05 or 06 strands in a round duct

Minimum radii of curvature

Practical experience and analytical models have shown that the contact pressure between strands and duct and between duct and concrete increases, in a linear fashion, with the local curvature of the post-tensioning tendon. Thus, the minimum radius of curvature of a tendon, R_{min} , can be expressed in terms of the prestressing force of the tendon, $F_{pm,0}$, the diameter of the strand, (e.g. $d = 15.7$ mm), the inner duct diameter, d_i , and the recommended allowable contact pressure, $p_{R,max}$, using the following equation:

$$R_{min} = \frac{2 \cdot F_{pm,0} \cdot d}{d_i \cdot p_{R,max}} > R_b$$

Where R_b is a limiting minimum radius of curvature, to avoid yield due to bending of the strands.

Table 13: Limiting radii of curvature for 05 and 06 strands

Type of strands	R_b
	m
05	1.7
06	2.0

Where the stable factor (K_f) is known precisely – as, for example, with CONA CMB tendons – then the following equation can be used to obtain the minimum radius of curvature:

$$R_{min} = \frac{F_{pm,0} \cdot K_f}{n \cdot p_{R,max}}$$

where n is the number of strands in the tendon and K_f the number of strands laying on top of each other (see Figure 7).

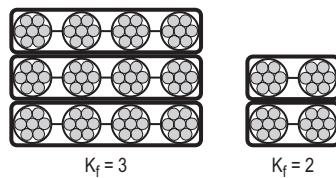

Figure 7: K_f factors in different strand configurations

Depending on the concrete strength at the time of stressing, additional reinforcement for splitting forces may be required in the areas of reduced minimum radii of curvature. Standards and regulations on minimum radii of curvature or allowable contact pressure under the prestressing strands applicable at the place of use must be complied with.

Typical recommended values for the allowable contact pressure under the prestressing strands are:

- ◆ $p_{R,max} = 140 - 200$ kN/m
CONA CMI and CONA CMF, internal bonded tendons with corrugated steel or plastic ducts
- ◆ $p_{R,max} = 140 - 200$ kN/m
CONA CMB, external band tendons
- ◆ $p_{R,max} = 350$ kN/m
CONA CME, external tendons with smooth steel or plastic ducts
- ◆ $p_{R,max} = 800$ kN/m
CONA CMI, bonded loop tendons with smooth steel ducts

Tables of minimum radii of curvature have been pre-calculated and are presented in the Annex. The values have been calculated assuming a prestressing force of $0.85 \cdot F_{p0,1}$. Therefore the given values are conservative and can be applied for other strand types and prestressing forces. For strands with tensile strength $f_{pk} = 1,770$ MPa the values for the inner duct diameter (d_i) and the eccentricity (e) remain constant. The minimum radius (R_{min}) in these tables can be reduced by the factor $f_r = 0.952$ with the following equation:

$$R_{min,1770} = f_r \cdot R_{min,1860} \geq R_b$$

[See Annex](#)

Loop Tendons with CONA CMI internal post-tensioning system

Loop tendons are often used when there is no access to the dead end – for example for vertical post-tensioning in tanks and silos. In this scenario, the straight part of the tendon is inside the concrete wall and the loop is in the basement. Due to the reduced radius of curvature, the contact pressure between the strands and the duct becomes very high, $p_{R,max} > 800$ kN/m. For the straight part, corrugated steel or plastic ducts can be used, whereas a smooth steel duct is selected for the curved portion. For ease of installation, the degree of filling chosen for the curved part should be around 0.25, but not less.

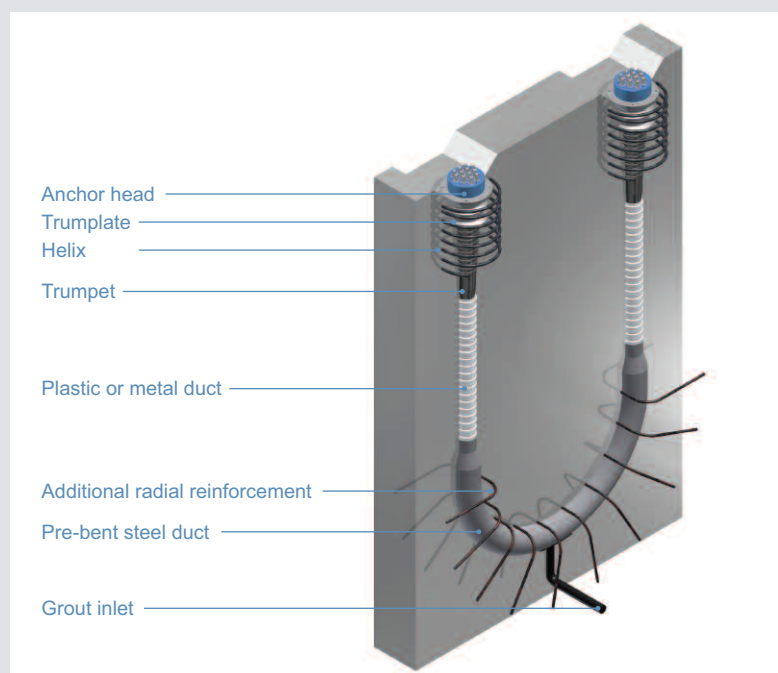

Minimum straight length after the anchorage

At the anchorages and couplers, the tendon layout should generally provide a minimum straight section beyond the end of the trumpet, see Figure 8. In the case of continuous tendons, in which the degree of filling is $0.35 \leq f \leq 0.50$ and with a minimum or reduced radius of curvature after the trumpet, the minimum straight length must be:

$$L_{min} = 5 \cdot d_i \geq 250mm$$

On the other hand, for continuous tendons with smaller degrees of filling $0.25 \leq f \leq 0.30$, the minimum straight length must be:

$$L_{min} = 8 \cdot d_i \geq 400mm$$

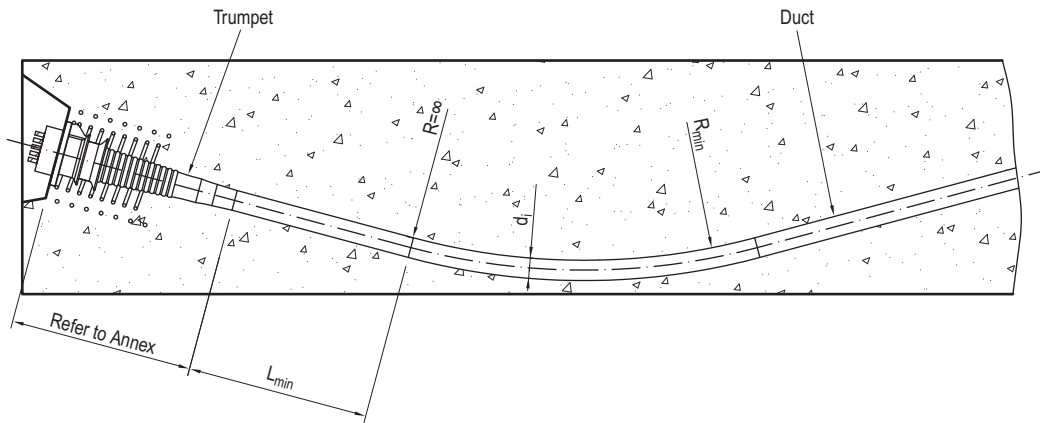

Figure 8: Radius of curvature and minimum straight length

Deviators and saddles for external post-tensioning

The deviator, see Figure 9, has to transfer the transversal forces (radial to the deviator) and longitudinal forces (tangential to the deviator) generated by a deviated external tendon to the structure. Moreover, deviators have to provide a smooth surface for the tendon. The deviator can be made of steel, HDPE or equivalent in respect to the structural and surface requirements.

To avoid any kinking of the tendon it is recommended, that an additional deviation ($\Delta\alpha$) of 3° with $R_2 < R_{min}$, is provided as shown in Figure 9.

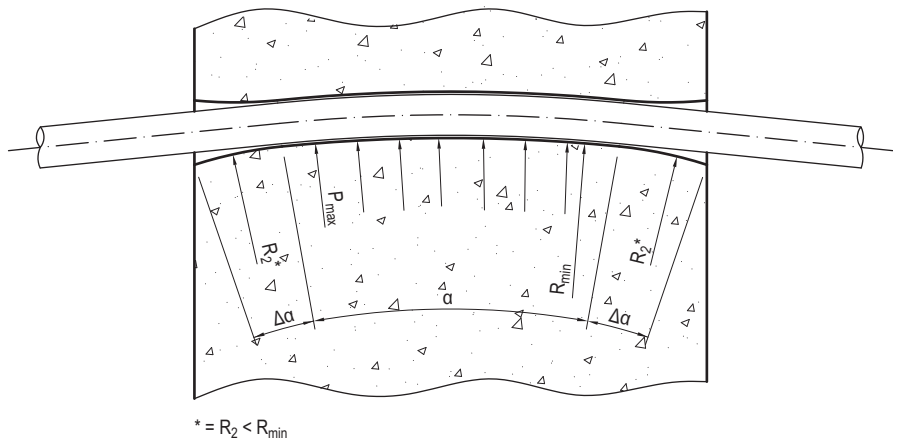

Figure 9: Minimum radius of curvature in deviators and saddles

See Annex

Support of tendons

In order to ensure the correct tendon profile and to prevent flotation, displacement due to concreting or disconnections due to impacts, tendon supports need to be provided at regularly spaced intervals, see Figure 10. Generally, the spacing of the supports needs to be between 1.0 to 1.8 m although this may need to be reduced in certain locations:

- ◆ Spacing of 0.8 m in the region of maximum tendon curvature.
- ◆ Spacing of 0.6 m whenever the minimum radius of curvature is less than 4.0 m.

Note that an improperly secured duct might lead to excessive tendon wobble and therefore a higher friction loss. Additionally, excessive wobble or inadequate duct alignment might complicate or even impede the tendon installation.

For electrically isolated tendons, depending on the regulations at the place of use, the duct may be supported by an additional sheathing at the regions of maximum tendon curvature.

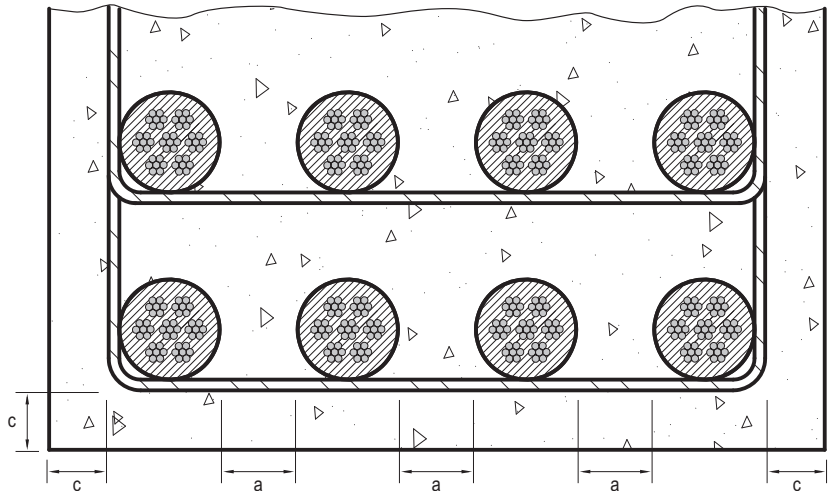

Figure 10: Tendon support on reinforcement and tendon layout

Tendon layout

The layout of the tendons in the general zone is shown in Figure 10. The following distances have to be obeyed:

- ◆ concrete cover, c.
- ◆ distance a, bigger than the maximum gravel diameter and sufficient space for vibrating concrete

Free tendon layout with the CONA CMM Single & Two/Four monostrand system

The free tendon layout technique for unbonded applications such as the CONA CMM Single & Two/Four monostrand system was established in Austria and offers a significant time and cost optimization. Cost reductions of 20% have been achieved. This innovative method allows placement of tendons without any tendon supports in slabs with a thickness of smaller than 450 mm. One of the key benefits of the free tendon layout method is that the tendon is only fixed on two high points to the upper reinforcement over supporting columns or walls. At midspan, the tendon is located on the lower reinforcement. No chairs are required between the high and low point. The vertical profile of the tendon was investigated in detail and a parabolic drape was observed.

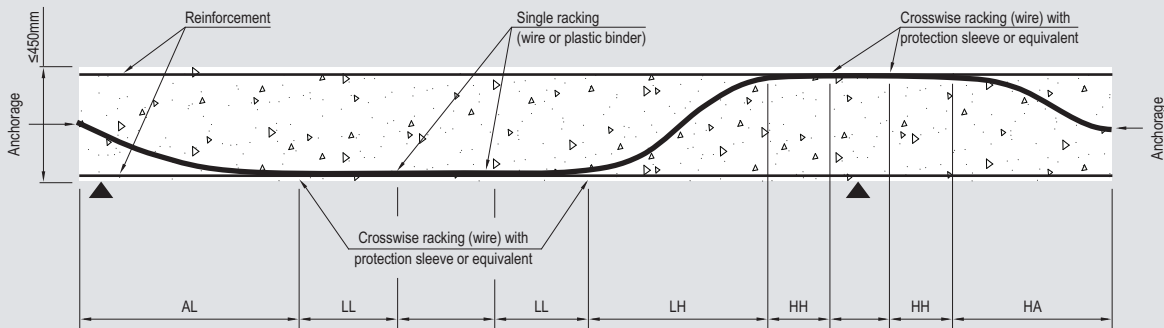

Sections		Max. distances of fixing points
AL	Anchorage to Low point	3.0 m
LL	Low point to Low point	1.0 m - 1.3 m
LH	Low point to High point	3.0 m
HH	High point to High point	0.3 m - 1.0 m
HA	High point to Anchorage	1.5 m

Anchor Zone

Concrete strength at the time of stressing

At the time of stressing, the mean concrete compressive strength ($f_{cm,0}$) must be at least the value given in the working tables, as shown in the Annex or European Technical Approvals of the respective CONA CMX strand post-tensioning kit. The concrete test specimen must also be subjected to the same curing conditions as the structure. Table 14 shows the minimum concrete compressive strength at the time of stressing – cylindrical and cubic – applicable for the various CONA CMX post-tensioning kits. Application of the full post-tensioning load is possible at much lower concrete strengths than a traditional single bearing plate configuration through use of the proprietary CONA CMI BT anchorage.

Table 14: Minimum concrete strength

	$f_{cm,cylinder}$	$f_{cm,cube}$
	MPa	
CONA CMI	≥19	≥23
CONA CME	≥19	≥23
CONA CMF	≥17	≥21
CONA CMM	≥20	≥24
CONA CMB	≥29	≥35

Partial initial prestressing

For partial initial prestressing with 30 % of the full prestressing force the actual mean value of the concrete compressive strength must be at least $0.5 \cdot f_{cm,0,cube}$ or $0.5 \cdot f_{cm,0,cylinder}$ (See Figure 11).

Local zone reinforcement

Figure 12 shows a comparison of the typical longitudinal and transverse stress distributions between a traditional single bearing plate (CONA CMI SP) anchorage and a CONA CMI BT (Bearing Trumplate) anchorage. At the anchorage, point loading of the concrete leads to compression and bursting stresses in the local zone as the stress field normalises towards the general zone. The CONA CMI BT allows for very small centre and edge distances at the anchorage via a proprietary three – plane load transfer which significantly reduces the peak bursting stresses. The Bearing Trumplate (BT) system is available for both internal (CMI) and external (CME) post – tensioning systems.

Confining reinforcement in the form of a helix cage is required in the local zone to resist the bursting stresses, while additional stirrups are specified to aid the helix in reducing crack widths under various loading conditions. Local zone reinforcement is given in the working tables shown in the Annex, or in the European Technical Approvals of the relevant CONA CMX system. While ribbed reinforcing steel grade Re > 500 MPa is

specified for all CONA CMX post-tensioning kits, alternative reinforcing steel such as grade Re > 460 MPa may be substituted if appropriate considerations are taken.

Reinforcement which exceeds the reinforcement required for the structure may be used as additional reinforcement for the local anchorage zone if appropriate placing is possible.

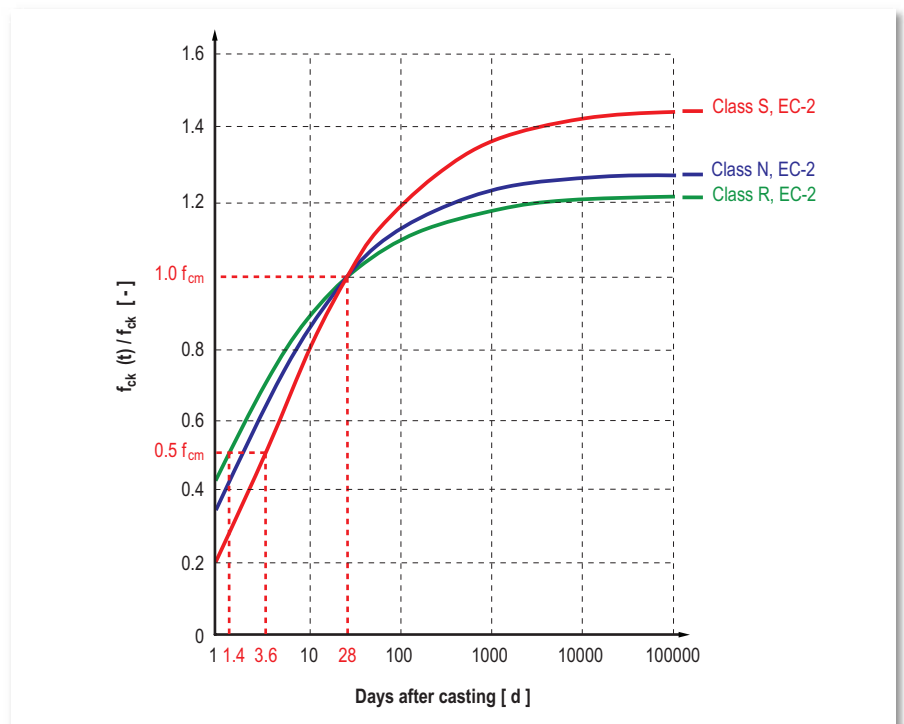

Figure 11: Concrete hardening

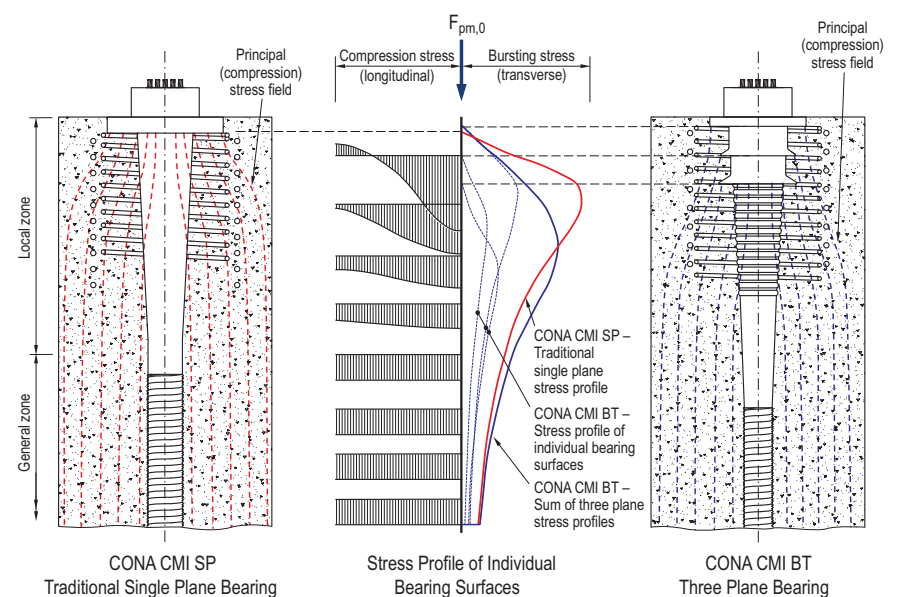

Figure 12: Stress distribution induced in concrete by a prestressing tendon

Centre spacing and edge distance

The centre spacing distances, a_c and b_c , and edge distances, a_e and b_e , see Figure 13, between individual anchorages are shown in the working tables in the Annex and the European Technical Approvals of the respective CONA CMX post-tensioning kit or for special applications these can be obtained as datasheets from the ETA Holder, BBRVT International Ltd. In general, these distances must be observed, although a reduction of up to 15% for the centre spacing is permitted provided adjustments to other dimensions are made as follows:

- ◆ The reduction should only be applied in one direction, either a_c or b_c , while the counterpart dimension must increase accordingly so that the concrete area, $A_c = a_c \cdot b_c$, is not reduced.
- ◆ The new reduced centre distances, a_c and b_c , should not be less than the outside diameter of the helix and be able to allow a suitable placing of the additional reinforcement, see Figure 13.

Modification of centre and edge distances must be made using the following expressions:

$$A_c = a_c \cdot b_c \leq a_e \cdot b_e$$

$$b_c \geq 0.85b_e \geq OD_{\text{Helix}}$$

$$a_e \geq \frac{A_c}{b_e}$$

After the 15% centre spacing reduction is applied, the corresponding modified edge distances are:

$$a_e = \frac{a_c}{2} - 10 + c \quad b_e = \frac{b_c}{2} - 10 + c$$

where in the latter expression, c refers to concrete cover. Standards and regulations on concrete cover in force at the place of use must be complied with. Typical values for concrete cover are listed in Table 7. Verification of the transfer of the prestressing forces to the structural concrete is not required if the centre spacing and edge distances of the tendons, as well as grade and dimensions of additional local zone reinforcement, are complied with. Should smaller centre spacing or edge distances, or different reinforcement steel be needed, please contact your nearest BBR representative for further information. In the case of grouped anchorages, the additional reinforcement of the individual anchorages can be combined, provided appropriate anchorage is ensured.

Efficient detailing with BBR VT CONA CMX

The CONA CMI BT (bearing trumplate) system makes use of an advanced and proprietary three plane load transfer; allowing for very small centre and edge distances at the anchorages, as well as application of the full post-tensioning load at very low concrete strengths. The CONA CMI SP (square plate) is a more traditional system with a single plane load transfer to the concrete structure.

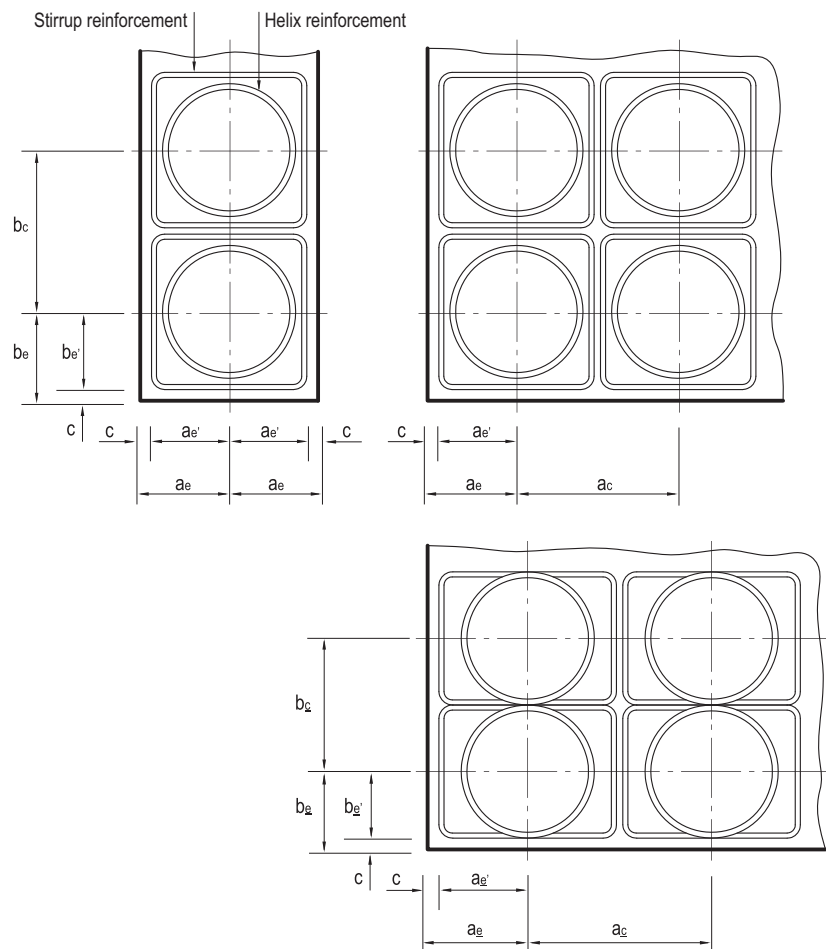
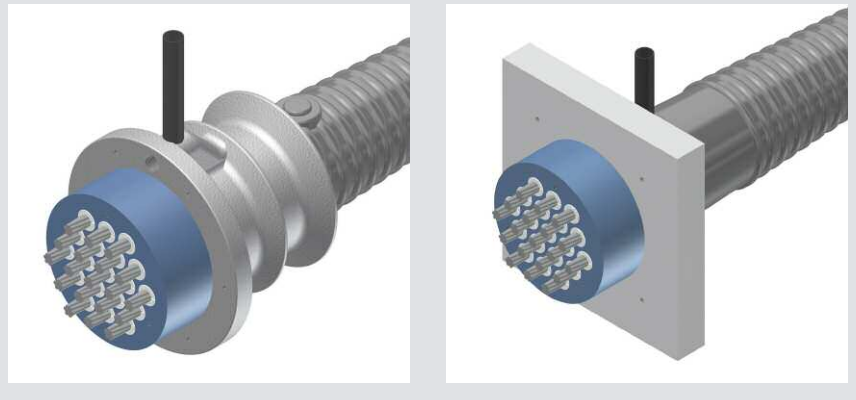
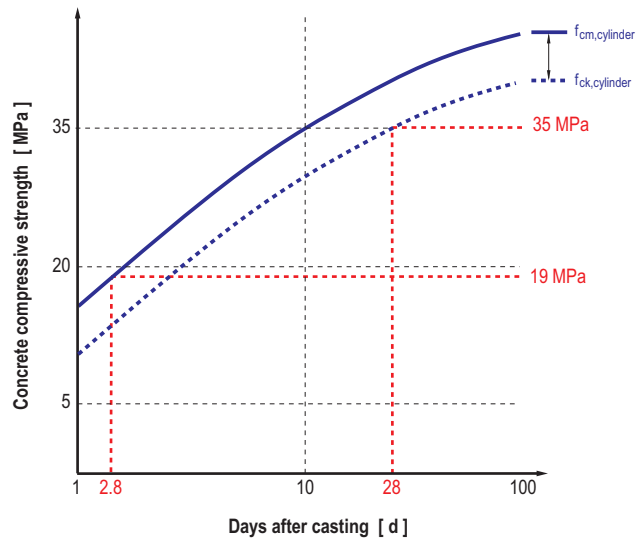

Figure 13: Dimensions of tendon center spacing and edge distance

See Annex

Earlier prestressing with BBR VT CONA CMX

The CONA CMX strand post-tensioning range allows prestressing to take place at very low mean concrete compressive strengths. In particular, for the CONA CMI BT, the lowest mean cylindrical compressive strength at the time of full prestressing is 19 MPa. The graph shows the hardening of a conventional concrete C35/45 with a characteristic cylindrical compressive strength equal to 35 MPa at 28 days after casting ($f_{ck, cylinder}$). If the local zone detailing is chosen according to $f_{cm,0, cylinder} = 19$ MPa for the CONA CMI BT post-tensioning kit, full prestressing can be performed approximately 3 days after casting.



Space requirements for stressing jacks and anchorage details

Table 15 shows the space requirements for stressing jacks and anchorage recess details in the immediate vicinity of a post-tensioning anchor. The spacing requirements and recess details are indicated for guidance purposes only and should be verified with your local BBR representative.

Table 15: Space requirements for stressing jacks and anchor recesses

Tendon Unit		CMF ³⁾	CMM (Single)	CMM (Two)	CMM (Four)	04 06	07 06	12 06	19 06	22 06	31 06	42 06	55 06
Dimensions (mm) ^{1) 4)}	A x A	100 x 100 ²⁾	100 x 130 ²⁾	160	180	230	270	340	420	420	460	560	650
	B	100	60	60	60	140	140	150	165	165	185	200	225
	C x C	140 x 200 ²⁾	100 x 130 ²⁾	190	220	310	370	400	510	510	560	660	750
	D	1,100	700	1,250	1,300	1,400	1,500	1,600	1,720	1,810	2,000	2,300	2,600
	E	170	80	100	130	250	300	330	345	400	600	600	600
	F	170	80	100	130	200	230	260	280	330	500	420	450

1) Jack spacing requirements and recess detailing are for guidance purposes only and should be verified with your local BBR representative.

2) Recess details are rectangular as indicated.

3) The recess details indicated are for use with a grout port extending from the trumpet. If the grout port is extended from the bearing trumplate, a larger recess detail is required.

4) In case of narrow available space or larger jack sizes, please contact your local BBR representative.

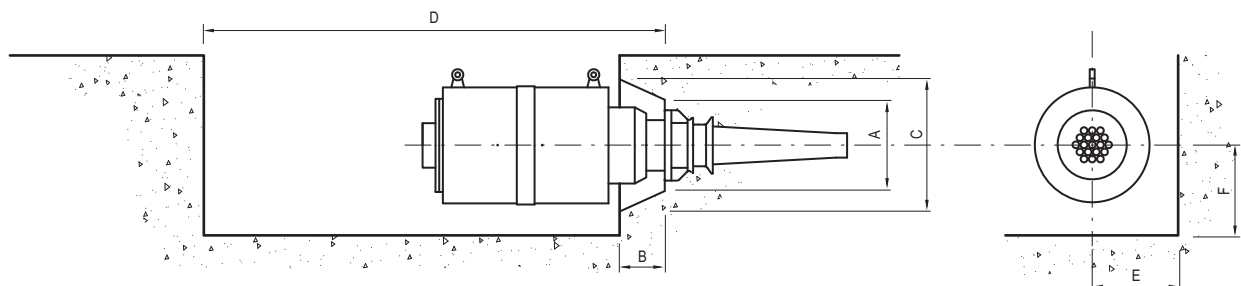

Figure 14: Dimensions of space requirements

Annex – CONA CMI BT/SP



Table 16: CONA CMI component dimensions

Number of strands		01	02	03	04	05	06	07	08	09	12	13	15	16	19	22	24	25	27	31	37	42	43	48	55	61	69	73
Bearing trumplate	Diameter	mm	130	130	170	170	170	170	195	225	225	240	280	280	280	310	325	360	360	360	400	425	485	485	485	520		
	Height	mm	120	120	120	128	128	128	133	150	150	160	195	195	195	206	227	250	250	250	275	290	340	340	340	350		
	Side length	mm	80	140	145	155	185	190	205	225	255	265	285	320	330	340	370	390	405	415	440	480	510	520	550	595	620	
Square plate ¹⁾	Thickness	mm	20	20	20	25	30	35	35	35	35	40	45	45	50	55	55	60	60	60	60	70	75	80	90	90		
	Nominal Diameter	mm	50	90	100	100	130	130	130	150	160	160	180	200	200	200	225	240	255	255	285	300	320	325	335	365		
	Height head A1-A4	mm	50	50	50	50	55	55	60	60	60	65	72	75	80	85	95	100	100	105	110	-	-	-	-	-		
Anchor head	Height head A5-A8	mm	65	65	65	65	65	65	65	65	70	72	75	80	85	95	100	100	105	110	120	130	130	140	150	155		
	Diameter	mm	185	185	185	205	205	205	240	240	240	240	290	290	290	310	340	390	390	390	390	-	-	-	-	-		
	Height	mm	85	85	85	85	85	85	90	90	90	90	90	90	95	105	120	125	125	130	-	-	-	-	-	-		
Coupler head type K	Nominal diameter	mm	50	90	100	130	130	150	160	160	180	200	200	200	200	225	240	255	255	285	300	320	325	335	365			
	Height head H1	mm	50	50	50	55	60	65	65	70	80	80	80	85	95	100	100	100	105	115	-	-	-	-	-	-		
	Height head H2	mm	65	65	65	65	65	65	65	65	70	70	70	75	85	95	100	100	105	115	125	135	135	145	160	160		
Coupler sleeve type H	Diameter	mm	69	111	121	130	160	164	167	189	200	210	230	256	266	293	309	324	327	335	370	392	410	422	440	472		
	Length sleeve	mm	180	180	180	180	180	190	200	200	210	230	240	250	270	270	280	280	300	320	340	360	360	380	410	410		
	BT anchorage	mm	-	295	295	295	431	431	431	721	738	623	819	854	854	739	886	1063	1086	1086	971	1300	1315	1549	1549	1605		
Assemblies	SP anchorage	mm	-	441	441	446	431	436	690	774	774	834	939	939	944	1072	1251	1210	1210	1210	1340	1390	1581	1581	1596	1774		
	Coupler K	mm	-	550	550	550	720	720	930	925	810	970	970	970	975	860	935	1200	1380	1380	1270	-	-	-	-	-		
	Coupler H	mm	-	660	660	660	830	840	850	1055	1065	970	1130	1140	1150	1055	1120	1380	1555	1575	1480	-	-	-	-	-		

On request

On request

¹⁾ Square plate dimensions may be optimised depending on the strength of concrete at transfer. Please contact your nearest BBR representative or refer to the CONA CMI ETA document.

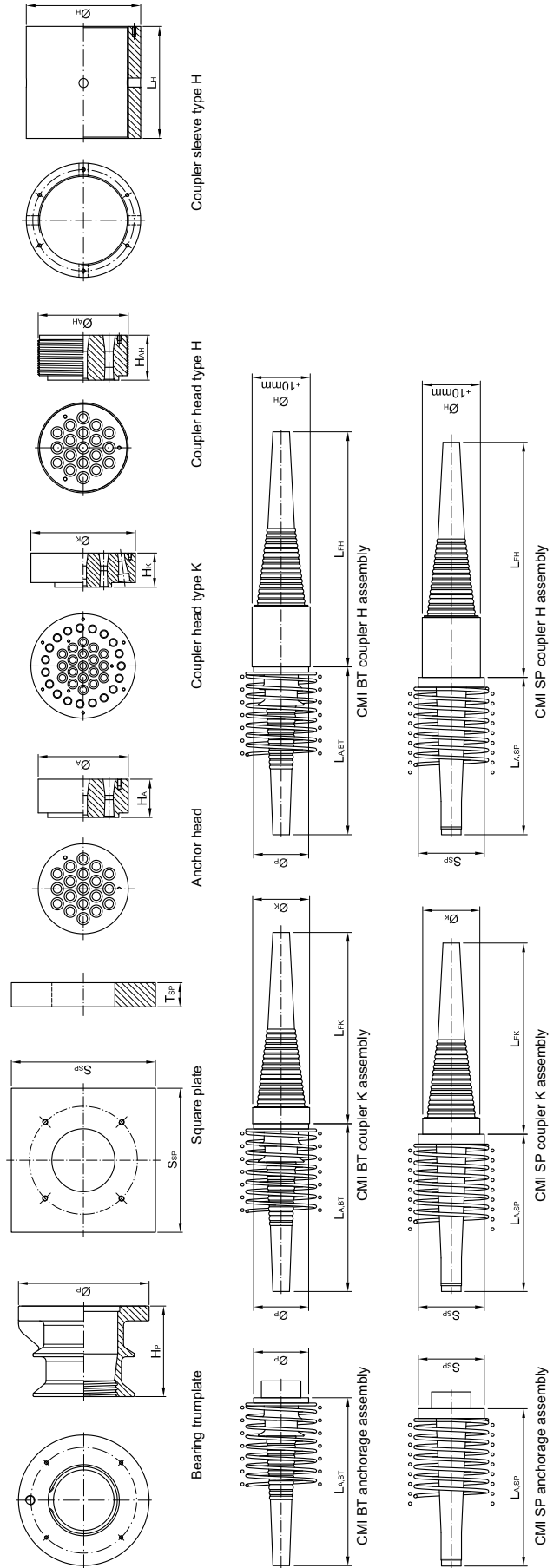

Annex – CONA CMI BT/SP



CONA CMI anchorage and couple configurations



CONA CMI BT Anchorage



CONA CMI Coupler K



CONA CMI Coupler H

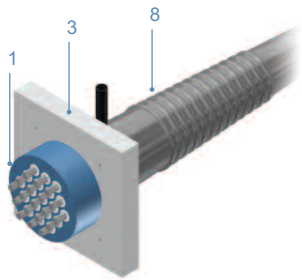

CONA CMI SP Anchorage

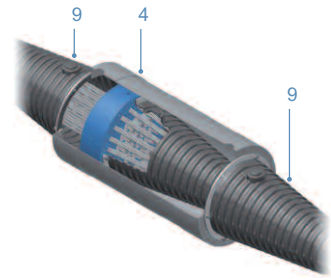

CONA CMI Moveable Coupler BK

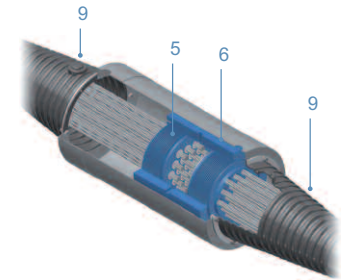

CONA CMI Moveable Coupler BH

- 1 – Anchor head
- 2 – Bearing trumplate
- 3 – Square plate
- 4 – Coupler head type K
- 5 – Coupler head type H
- 6 – Coupler sleeve type H
- 7 – Trumpet type A
- 8 – Trumpet type A SP
- 9 – Trumpet type K
- * – Shown

Loop tendon minimum radii of curvature

In Table 17, the minimum radii of curvature (R_{min}), outer duct diameter (d_o) and duct thickness (t) are given with corresponding eccentricities (e) and degrees of filling (f).

Nevertheless other duct sizes can be used, taking due consideration of the minimum wall thickness given in the far right column of the table. Different duct sizes lead to different eccentricities and minimum radii of curvature.

Table 17: Minimum radii of curvature and eccentricity for loop tendons with $p_{R,max} = 800$ kN/m

n 06 Number of strands	06-140 1860					06-150 1860					Min. wall thickness t_{min} mm
	d_o	t	R_{min}	e	f	d_o	t	R_{min}	e	f	
	mm	mm	m	mm	-	mm	mm	m	mm	-	
04 06	60.3	2.9	0.5	13	0.24	60.3	2.9	0.6	12	0.26	1.5
05 06	63.5	2.9	0.6	14	0.27	63.5	2.9	0.7	13	0.29	1.5
06 06	70	2.9	0.7	15	0.26	70	2.9	0.7	14	0.28	1.5
07 06	76.1	2.9	0.7	17	0.25	76.1	2.9	0.8	19	0.27	1.5
08 06	82.5	3.2	0.8	18	0.25	82.5	3.2	0.8	21	0.26	1.5
09 06	82.5	3.2	0.9	19	0.28	88.5	3.2	0.9	23	0.26	1.5
12 06	95	3.6	1.0	21	0.28	95	3.6	1.1	22	0.30	1.5
13 06	101.6	3.6	1.0	23	0.26	101.6	3.6	1.1	25	0.28	1.5
15 06	108	3.6	1.1	26	0.26	114.3	3.6	1.1	26	0.25	2.0
16 06	114.3	3.6	1.1	26	0.25	114.3	3.6	1.2	29	0.27	2.0
19 06	121	4	1.3	28	0.27	121	4	1.3	29	0.28	2.0
22 06	133	4	1.3	31	0.25	133	4	1.4	33	0.27	2.0
24 06	139.7	4	1.4	32	0.25	139.7	4	1.5	35	0.26	2.0
25 06	139.7	4	1.4	33	0.26	139.7	4	1.5	35	0.28	2.0
27 06	139.7	4	1.5	35	0.28	152.4	4.5	1.5	39	0.25	3.0
31 06	152.4	4.5	1.6	37	0.27	159	4.5	1.7	40	0.26	3.0

Annex – CONA CMI BT/SP

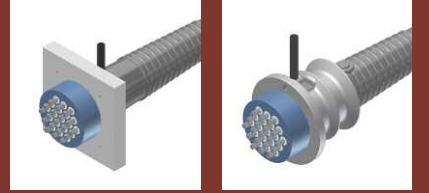

CONA CMI minimum radii of curvature

In Tables 18 to 20, the minimum radii of curvature (R_{min}), eccentricity (e) and inner duct diameter (d_i) are given for various degrees of filling (f), assuming a prestressing

force of the tendon of $0.85 F_{p0,1}$, a diameter of the strands (d) of 12.9 mm (05-100 1860), 15.3 mm (06-140 1860), or 15.7 mm (06-150 1860) and allowable contact pressures of 140 kN/m or 200 kN/m.

Duct diameters marked with * are available as BBRVT Plastic Ducts. The most common diameters are underlined in the following tables.

Table 18: CONA CMI minimum radii of curvature and eccentricity for strands 05-100 1860 and $p_{R,max} = 140$ and 200kN/m

Degree of filling	$f \approx 0.35$				$f \approx 0.40$				$f \approx 0.45$			
	d_i	R_{min}		e	d_i	R_{min}		e	d_i	R_{min}		e
		140 kN/m	200 kN/m			140 kN/m	200 kN/m			140 kN/m	200 kN/m	
n 05 Number of strands ($A_p = 100 \text{ mm}^2$)	mm	m		mm	mm	m		mm	mm	m		mm
01 05	<u>20</u>	1.7	1.7	4	<u>20</u>	1.7	1.7	4	<u>20</u>	1.7	1.7	4
02 05	<u>30</u>	1.7	1.7	6	<u>30</u>	1.7	1.7	6	<u>30</u>	1.7	1.7	6
03 05	<u>35</u>	2.2	1.7	6	<u>30</u>	2.6	1.8	2	<u>30</u>	2.6	1.8	2
04 05	40	2.6	1.8	8	<u>35</u>	2.9	2.1	4	<u>35</u>	2.9	2.1	4
07 05	<u>50</u> *	3.6	2.5	8	<u>50</u> *	3.6	2.5	8	<u>45</u>	4.0	2.8	5
12 05	<u>65</u>	4.7	3.3	11	60 *	5.1	3.6	7	60 *	5.1	3.6	8
19 05	85 *	5.7	4.0	16	<u>80</u>	6.1	4.3	13	75 *	6.5	4.6	9
31 05	105	7.6	5.3	19	100 *	8.0	5.6	15	<u>95</u>	8.4	5.9	12

Table 19: CONA CMI minimum radii of curvature and eccentricity for strands 06-140 1860 and $p_{R,max} = 140$ and 200kN/m

Degree of filling	$f \approx 0.35$				$f \approx 0.40$				$f \approx 0.45$			
	d_i	R_{min}		e	d_i	R_{min}		e	d_i	R_{min}		e
		140 kN/m	200 kN/m			140 kN/m	200 kN/m			140 kN/m	200 kN/m	
n 06 Number of strands ($A_p = 140 \text{ mm}^2$)	mm	m		mm	mm	m		mm	mm	m		mm
01 06	23 *	2.0	2.0	4	<u>20</u>	2.1	2.0	3	<u>20</u>	2.1	2.0	3
02 06	<u>35</u>	2.4	2.0	7	<u>35</u>	2.4	2.0	6	<u>35</u>	2.4	2.0	6
03 06	40	3.2	2.2	6	<u>35</u>	3.6	2.6	2	<u>35</u>	3.6	2.6	2
04 06	<u>45</u>	3.8	2.6	7	40	4.3	3.0	3	40	4.3	3.0	3
05 06	50 *	4.3	3.0	8	<u>45</u>	4.7	3.3	4	<u>45</u>	4.7	3.3	4
06 06	<u>55</u>	4.6	3.2	9	50 *	5.1	3.6	6	50 *	5.1	3.6	6
07 06	60 *	5.0	3.5	10	<u>55</u>	5.4	3.8	7	<u>55</u>	5.4	3.8	7
08 06	<u>65</u>	5.2	3.7	11	60 *	5.7	4.0	8	<u>55</u>	6.2	4.3	4
09 06	70	5.5	3.8	13	<u>65</u>	5.9	4.1	10	60	6.4	4.5	6
12 06	<u>80</u>	6.4	4.5	15	75 *	6.8	4.8	12	70	7.3	5.1	8
13 06	80	6.9	4.8	15	75 *	7.4	5.2	10	70	7.9	5.5	6
15 06	85 *	7.5	5.3	14	<u>80</u>	8.0	5.6	10	75 *	8.5	6.0	7
16 06	90	7.6	5.3	16	85 *	8.0	5.6	12	<u>80</u>	8.5	6.0	9
19 06	100 *	8.1	5.7	19	90	9.0	6.3	11	85 *	9.5	6.7	8
22 06	105	8.9	6.2	19	100 *	9.4	6.6	15	<u>95</u>	9.9	6.9	11
24 06	<u>110</u>	9.3	6.5	20	105	9.7	6.8	16	100 *	10.2	7.1	12
25 06	115 *	9.2	6.5	22	105	10.1	7.1	15	100	10.6	7.4	11
27 06	115 *	10.0	7.0	20	<u>110</u>	10.4	7.3	16	105	10.9	7.7	13
31 06	<u>125</u>	10.6	7.4	22	120	11.0	7.7	19	<u>110</u>	12.0	8.4	12
37 06	135	11.7	8.2	23	130 *	12.1	8.5	19	120	13.1	9.2	13
42 06	145	12.3	8.6	25	135	13.2	9.3	20	130 *	13.7	9.6	16
43 06	150	12.2	8.5	28	<u>140</u>	13.1	9.1	20	130 *	14.1	9.9	15
48 06	155	13.2	9.2	30	145	14.1	9.9	21	<u>140</u>	14.6	10.2	17
55 06	165	14.2	9.9	29	155	15.1	10.6	22	145	16.1	11.3	18
61 06	<u>175</u>	14.8	10.4	32	165	15.7	11.0	23	155	16.7	11.7	18
69 06	185	15.9	11.1	34	<u>175</u>	16.8	11.7	25	165	17.8	12.5	19
73 06	195	15.9	11.1	36	180	17.3	12.1	26	170	18.3	12.8	20

Annex – CONA CMI BT/SP



Table 20: CONA CMI minimum radii of curvature and eccentricity for strands 06-150 1860 and $p_{R,max} = 140$ and 200 kN/m

Degree of filling	$f \approx 0.35$				$f \approx 0.40$				$f \approx 0.45$				
	n 06 Number of strands ($A_p = 150 \text{ mm}^2$)	d_i	R_{min}		e	d_i	R_{min}		e	d_i	R_{min}		e
			140 kN/m	200 kN/m			140 kN/m	200 kN/m			140 kN/m	200 kN/m	
		mm	m		mm	mm	m		mm	mm	m		mm
01 06	23 *	2.0	2.0	4	23 *	2.0	2.0	4	<u>20</u>	2.3	2.0	2	
02 06	<u>35</u>	2.7	2.0	6	<u>35</u>	2.7	2.0	6	<u>35</u>	2.7	2.0	6	
03 06	40	3.5	2.5	6	40	3.5	2.5	6	<u>35</u>	4.0	2.8	1	
04 06	<u>45</u>	4.2	2.9	6	<u>45</u>	4.2	2.9	6	40	4.7	3.3	2	
05 06	50 *	4.7	3.3	8	50 *	4.7	3.3	8	<u>45</u>	5.2	3.6	3	
06 06	<u>55</u>	5.1	3.6	8	<u>55</u>	5.1	3.6	8	50 *	5.6	3.9	5	
07 06	60 *	5.5	3.8	9	60 *	5.5	3.8	9	<u>55</u>	6.0	4.2	6	
08 06	<u>65</u>	5.8	4.0	11	60 *	6.3	4.4	6	60 *	6.3	4.4	7	
09 06	70	6.0	4.2	12	<u>65</u>	6.5	4.5	9	60 *	7.0	4.9	4	
12 06	<u>80</u>	7.0	4.9	14	75 *	7.5	5.3	11	70	8.0	5.6	7	
13 06	85 *	7.2	5.0	16	<u>80</u>	7.6	5.3	13	75 *	8.1	5.7	9	
15 06	90	7.8	5.5	16	85 *	8.3	5.8	13	<u>80</u>	8.8	6.2	9	
16 06	<u>95</u>	7.9	5.5	18	85 *	8.8	6.2	11	85 *	8.8	6.2	10	
19 06	100 *	8.9	6.2	17	<u>95</u>	9.4	6.6	14	90	9.9	6.9	10	
22 06	<u>110</u>	9.4	6.6	21	100 *	10.3	7.2	13	<u>95</u>	10.9	7.6	10	
24 06	115 *	9.8	6.9	21	105	10.7	7.5	15	100 *	11.3	7.9	11	
25 06	115 *	10.2	7.1	20	<u>110</u>	10.7	7.5	17	105	11.2	7.8	14	
27 06	<u>120</u>	10.6	7.4	21	115 *	11.0	7.7	18	105	12.1	8.4	11	
31 06	130 *	11.2	7.8	24	120	12.1	8.5	17	115 *	12.6	8.8	14	
37 06	<u>140</u>	12.4	8.7	25	130 *	13.3	9.3	19	<u>125</u>	13.9	9.7	15	
42 06	150	13.1	9.2	26	<u>140</u>	14.1	9.8	21	135	14.6	10.2	17	
43 06	155	13.0	9.1	28	145	13.9	9.7	22	135	14.9	10.5	16	
48 06	<u>160</u>	14.1	9.8	29	150	15.0	10.5	24	145	15.5	10.9	21	
55 06	<u>175</u>	14.7	10.3	31	<u>160</u>	16.1	11.3	26	150	17.2	12.0	21	
61 06	180	15.9	11.1	33	170	16.8	11.8	27	<u>160</u>	17.9	12.5	22	
69 06	195	16.6	11.6	35	180	18.0	12.6	29	170	19.0	13.3	23	
73 06	<u>200</u>	17.1	12.0	37	185	18.5	13.0	30	175	19.6	13.7	23	

Where BBRVT Plastic Ducts are used in tables 18 to 20 (denoted with an *), please refer to the relevant European Technical Approval or contact your nearest BBR representative.

Annex – CONA CMI BT/SP



Table 21: CONA CMI BT anchor zone spacing and local reinforcement requirement for strands 05-100 1860

CONA CMI BT n05		02 05			03 05			04 05			07 05			12 05			19 05			31 05						
Cube strength	f_{cm0} MPa	23	28	34	38	43	23	28	34	38	43	23	28	34	38	43	23	28	34	38	43	23	28	34	38	43
Cylinder strength	f_{cm0} MPa	19	23	28	31	35	19	23	28	31	35	19	23	28	31	35	19	23	28	31	35	19	23	28	31	35
Outer diameter HELIX	mm	160	160	160	160	160	160	160	160	160	155	200	195	195	195	195	280	260	255	250	250	375	330	315	305	305
Bar diameter	mm	10	10	10	10	10	10	10	10	10	10	10	10	10	10	10	14	12	12	12	12	14	14	14	14	14
Pitch	mm	45	45	45	45	45	45	45	45	45	45	45	50	50	50	50	50	50	50	50	50	50	50	50	50	50
Number of pitches		5	5	5	5	5	5	5	5	5	5	6	5	5	5	5	6	6	6	6	6	9	8	7	7	7
Distance	E mm	15	15	15	15	15	15	15	15	15	15	18	18	18	18	18	20	20	20	20	20	27	27	27	27	27
Number of STIRRUPS		3	3	3	3	3	4	4	4	4	4	4	4	4	4	4	5	5	5	5	5	7	6	5	5	5
Bar diameter	mm	8	8	8	8	8	8	8	8	8	8	10	10	10	10	10	12	12	12	12	12	14	14	14	14	14
Spacing	mm	55	55	55	55	55	55	55	55	55	55	55	50	50	50	50	60	55	55	55	55	60	65	65	65	65
Distance	F mm	30	30	30	30	30	30	30	30	30	30	30	33	33	33	33	35	35	35	35	35	42	42	42	42	42
Minimum outer dimensions	A = B mm	190	190	190	190	190	190	190	190	190	190	250	230	230	230	230	330	300	290	290	290	440	400	360	350	350
Centre spacing	$a_c = b_c$ mm	210	210	210	210	210	210	210	210	210	205	265	250	250	250	250	350	320	310	310	310	455	415	380	365	365
Edge distance (+ c)	$a_e = b_e$ mm	95	95	95	95	95	95	95	95	95	95	125	115	115	115	115	165	150	145	145	145	220	200	180	175	175

Table 22: CONA CMI SP anchor zone spacing and local reinforcement requirement for strands 05-100 1860

CONA CMI SP n05		01 05			02 05			03 05			04 05			07 05			12 05			19 05			31 05														
Cube strength	f_{cm0} MPa	26	28	34	38	43	46	26	28	34	38	43	46	26	28	34	38	43	46	26	28	34	38	43	46	26	28	34	38	43	46						
Cylinder strength	f_{cm0} MPa	21	23	28	31	35	38	21	23	28	31	35	38	21	23	28	31	35	38	21	23	28	31	35	38	21	23	28	31	35	38						
Outer diameter HELIX	mm	100	100	100	100	100	130	130	100	100	100	165	160	130	130	120	215	200	185	170	160	295	280	240	225	215	370	350	325	300	290	280					
Bar diameter	mm	10	10	10	10	10	10	10	10	10	10	10	10	10	10	10	10	10	10	10	10	14	14	14	14	14	14	14	14	14	14	14					
Pitch	mm	45	45	45	45	45	45	45	45	45	45	45	45	45	45	45	45	45	45	45	45	50	50	50	50	50	50	50	50	50	50	50					
Number of pitches		3	3	2.5	2.5	2.5	4	4	3.5	3.5	3.5	4	4	4	4	4	6	5.5	5	4.5	4.5	7	7	6	6	6	8.5	8	7.5	7.5	7	6.5					
Distance	E mm	20	20	20	20	20	20	20	20	20	20	20	20	20	20	20	30	30	30	30	30	35	35	35	35	35	45	45	45	45	45	45					
Number of STIRRUPS		2	2	2	2	2	2	2	2	2	2	3	3	3	3	3	4	4	4	4	4	5	5	5	5	5	7	6	6	6	6	6					
Bar diameter	mm	6	6	6	6	6	6	6	6	6	6	6	6	6	6	6	10	10	10	10	10	12	12	12	12	12	14	14	14	14	14	14					
Spacing	mm	80	75	70	65	60	60	110	110	60	55	90	90	80	80	30	35	35	35	175	170	50	60	80	75	75	75	90	85	110	75						
Distance	F mm	40	40	40	40	40	40	40	40	40	40	40	40	40	40	40	40	40	40	40	40	50	50	50	50	55	55	65	65	65	65	65	65				
Minimum outer dimensions	A = B mm	100	95	85	80	75	75	150	145	130	125	115	115	185	180	165	155	150	145	245	235	220	205	195	190	330	320	295	280	265	255						
Centre spacing	$a_c = b_c$ mm	120	115	105	100	95	95	170	165	150	145	135	135	205	200	185	175	170	165	265	255	240	225	215	210	355	340	315	300	285	275						
Edge distance (+ c)	$a_e = b_e$ mm	50	50	45	40	40	40	75	75	65	60	60	60	95	90	85	80	75	75	125	120	110	105	100	95	170	160	150	140	135	130	220	210	195	185	175	170

1) If smaller centre spacing and edge distances are required, refer to page 22 for guidance on space reduction. 2) All helix and stirrup reinforcement shall be ribbed reinforcing steel of grade 500 MPa. Grade 460 MPa steel may also be used if one additional stirrup of equivalent size is placed within the same length of the anchorage zone. The indicated stirrup spacings will have to be reduced accordingly. 3) Bar diameter of 14 mm can be replaced by 16 mm. 4) Prestressing strand with nominal diameter of less than 12.9 mm and cross sectional area of less than 100 mm² or with characteristic tensile strength below 1,860 MPa may also be used.

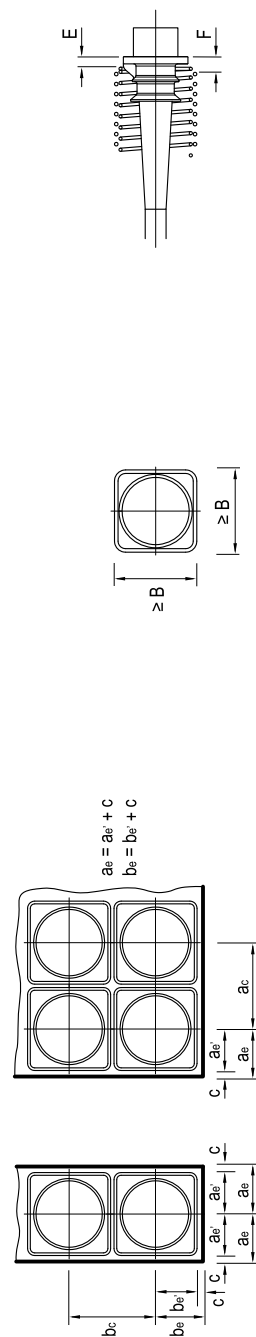

Annex – CONA CMI BT



Table 23: CONA CMI BT anchor zone spacing and local reinforcement requirement for strands 06- 150 1860

CONA CMI BT n06		02 06	03 06	04 06	05 06	06 06	07 06	08 06	09 06
Cube strength	f_{cm0} MPa	23 28 34 38 43	23 28 34 38 43	23 28 34 38 43	23 28 34 38 43	23 28 34 38 43	23 28 34 38 43	23 28 34 38 43	23 28 34 38 43
Cylinder strength	f_{cm0} MPa	19 23 28 31 35	19 23 28 31 35	19 23 28 31 35	19 23 28 31 35	19 23 28 31 35	19 23 28 31 35	19 23 28 31 35	19 23 28 31 35
Outer diameter	mm	160 160 160 160 155	160 160 160 160 155	180 160 160 160 160	200 195 195 195 195	200 200 195 195 195	230 200 200 200 200	270 230 225 220 220	280 260 255 250 250
Bar diameter	mm	10 10 10 10 10	10 10 10 10 10	10 10 10 10 10	10 10 10 10 10	10 10 10 10 10	12 12 12 12 12	14 12 12 12 12	14 12 12 12 12
Pitch	mm	45 45 45 45 45	45 45 45 45 45	45 45 45 45 45	45 50 50 60 50	45 50 50 60 50	45 50 50 50 50	50 50 50 50 50	50 50 50 50 50
Number of pitches		5 5 5 5 5	5 5 5 5 5	5 5 5 5 5	6 5 5 5 5	6 5 5 5 5	6 6 5 5 5	6 6 5 6 6	6 6 6 6 6
Distance	E mm	15 15 15 15 15	15 15 15 15 15	15 15 15 15 15	18 18 18 18 18	18 18 18 18 18	18 18 18 18 18	20 20 20 20 20	20 20 20 20 20
Number of STRIRUPS		3 3 3 3 3	3 3 3 3 3	3 3 3 3 3	4 4 4 4 4	4 4 4 4 4	4 4 4 4 4	4 4 4 4 4	4 4 4 4 4
Bar diameter	mm	8 8 8 8 8	8 10 8 8 8	10 12 10 10 10	12 12 12 12 12	12 12 12 12 12	14 14 12 14 14	12 12 12 14 14	12 12 14 14 14
Spacing	mm	55 55 55 55 55	45 55 45 45 45	60 55 45 45 45	55 50 50 65 50	55 50 55 65 55	60 55 55 65 55	70 45 50 55 50	60 55 55 65 55
Distance	F mm	30 30 30 30 30	30 30 30 30 30	30 30 30 30 30	33 33 33 33 33	33 33 33 33 33	33 33 33 33 33	33 33 33 33 33	35 35 35 35 35
Minimum outer dimensions	A = B mm	190 190 190 190 190	190 190 190 190 190	220 200 190 190 190	250 230 230 230 230	270 250 230 230 230	290 270 240 240 240	310 290 260 260 260	330 300 290 290 290
Centre spacing	$a_e = b_e$ mm	210 210 210 210 205	210 210 210 210 205	235 215 210 210 205	265 250 250 250 250	290 265 250 250 250	310 285 260 255 255	330 305 280 275 275	350 320 310 310 310
Edge distance (+ c)	$a_e' = b_e'$ mm	95 95 95 95 95	95 95 95 95 95	110 100 95 95 95	125 115 115 115 115	135 125 115 115 115	145 135 120 120 120	155 145 130 130 130	165 150 145 145 145
CONA CMI BT n06		12 06	13 06	15 06	16 06	19 06	22 06	24 06	25 06
Cube strength	f_{cm0} MPa	23 28 34 38 43	23 28 34 38 43	23 28 34 38 43	23 28 34 38 43	23 28 34 38 43	23 28 34 38 43	23 28 34 38 43	23 28 34 38 43
Cylinder strength	f_{cm0} MPa	19 23 28 31 35	19 23 28 31 35	19 23 28 31 35	19 23 28 31 35	19 23 28 31 35	19 23 28 31 35	19 23 28 31 35	19 23 28 31 35
Outer diameter	mm	330 280 275 260 250	375 330 300 280 270	375 330 315 305 305	420 360 360 330 325	475 420 390 360 340	475 430 410 360 360	520 430 420 390 380	
Bar diameter	mm	14 14 14 14 14	14 14 14 14 14	14 14 14 14 14	14 14 14 14 14	14 14 14 14 14	14 14 14 14 14	14 14 14 14 14	
Pitch	mm	50 50 50 50 50	50 50 50 50 50	50 50 50 50 50	50 50 50 50 50	50 50 50 50 50	50 50 50 50 50	50 50 50 50 50	
Number of pitches		7 7 7 7 6	8 8 8 7 6	9 9 9 8 7	9 9 9 8 7	10 10 9 8 7	10 10 9 8 7	11 10 10 9 8	
Distance	E mm	20 20 20 20 20	23 23 23 23 23	27 27 27 27 27	27 27 27 27 27	27 27 27 27 27	31 31 31 31 31	32 32 32 32 32	
Number of STRIRUPS		7 6 5 5 6	7 6 6 6 7	7 6 5 6 5	7 6 5 6 6	7 7 7 7 7	7 6 7 8 7	7 7 7 7 7	
Bar diameter	mm	12 14 16 16 14	12 14 14 14 14	14 16 16 16 16	14 16 16 16 16	16 16 16 16 16	20 20 20 20 20	20 20 20 20 20	
Spacing	mm	60 55 70 50 50	55 60 55 60 45	60 65 65 55 60	60 65 65 60 60	65 65 65 60 60	80 75 65 65 65	80 80 70 65 55	
Distance	F mm	35 35 35 35 35	40 40 40 40 40	42 42 42 42 42	42 42 42 42 42	42 42 42 42 42	46 46 46 46 46	47 47 47 47 47	
Minimum outer dimensions	A = B mm	390 350 320 310 290	410 370 340 320 310	440 400 360 350 350	450 410 370 360 350	490 450 410 390 370	530 480 440 420 400	560 510 460 440 420	
Centre spacing	$a_e = b_e$ mm	405 370 340 325 310	425 390 355 340 325	455 415 380 365 365	470 430 390 375 365	510 465 425 410 390	550 500 460 440 420	575 525 480 460 435	
Edge distance (+ c)	$a_e' = b_e'$ mm	195 175 160 155 145	205 185 170 160 155	220 200 180 175 175	225 205 185 180 175	245 225 205 195 185	265 240 220 210 200	280 255 230 220 210	

1) If smaller, centre spacing and edge distances are required, refer to page 22 for guidance on space reduction. 2) All helix and stirrup reinforcement shall be ribbed reinforcing steel of grade 500 MPa. Grade 460 MPa steel may also be used if one additional stirrup of equivalent size is placed within the same length of the anchorage zone. The indicated stirrup spacings will have to be reduced accordingly. 3) Bar diameter of 14 mm can be replaced by 16 mm. 4) Prestressing strand with nominal diameter of 140 mm² or with characteristic tensile strength below 1,860 MPa may also be used.

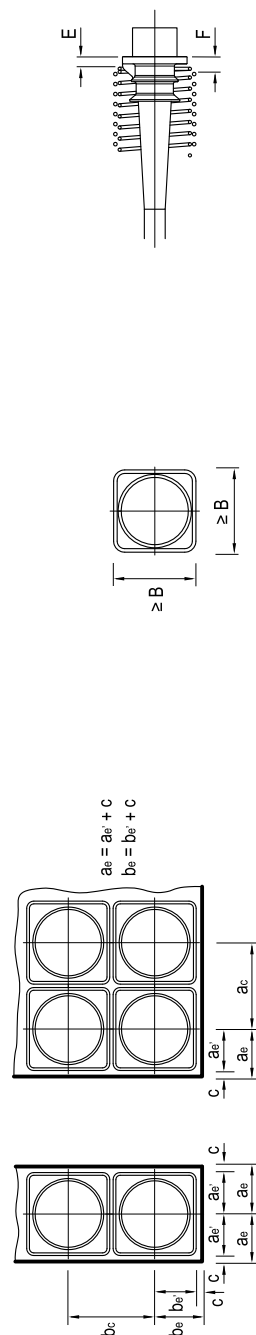
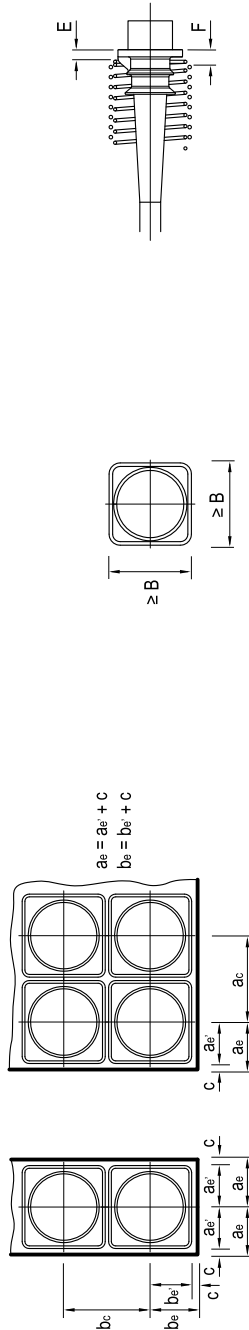



Table 23: CONA CMI BT anchor zone spacing and local reinforcement requirement for strands 06-150 1860 continued

CONA CMI BT n06		27 06			31 06			37 06			42 06			43 06			48 06			55 06			61 06													
Cube strength	f_{cm0} MPa	23	28	34	38	43	23	28	34	38	43	23	28	34	38	43	23	28	34	38	43	23	28	34	38	43	23	28	34	38	43	23	28	34	38	43
Cylinder strength	f_{cm0} MPa	19	23	28	31	35	19	23	28	31	35	19	23	28	31	35	19	23	28	31	35	19	23	28	31	35	19	23	28	31	35	19	23	28	31	35
Outer diameter HELIX	mm	520	475	440	420	390	560	520	475	430	430	580	580	580	580	580	630	630	630	630	630	670	670	670	670	670	710	710	710	710	710	780	780	780	780	780
Bar diameter	mm	14	14	14	14	14	14	14	14	14	14	16	16	16	16	16	16	16	16	16	16	16	16	16	16	16	16	16	16	16	16	20	20	20	20	20
Pitch	mm	50	50	50	50	50	50	50	50	50	50	50	50	50	50	50	50	50	50	50	50	50	50	50	50	50	50	50	50	50	50	60	60	60	60	60
Number of pitches		11	10	10	9	11	11	12	10	9	11	11	11	11	11	11	12	12	12	12	12	12	12	12	12	12	13	13	13	13	13	14	14	14	14	14
Distance	E mm	35	35	35	35	35	35	35	35	35	35	40	40	40	40	40	45	45	45	45	45	45	45	45	45	45	45	45	45	45	45	55	55	55	55	55
Number of STRIRUPS		8	7	8	8	8	9	8	8	8	8	9	9	9	9	9	10	10	10	10	10	10	10	10	10	10	11	11	11	11	11	11	11	11	11	11
Bar diameter	mm	20	20	20	20	20	20	20	20	20	20	20	20	20	20	20	20	20	20	20	20	20	20	20	20	20	20	20	20	20	20	20	20	20	20	20
Spacing	mm	80	80	75	60	60	80	75	60	60	60	70	70	70	70	70	70	70	70	70	70	70	70	70	70	70	70	70	70	70	70	75	75	75	75	75
Distance	F mm	50	50	50	50	50	50	50	50	50	50	50	50	50	50	50	55	55	55	55	55	55	55	55	55	55	55	55	55	55	55	55	55	55	55	55
Minimum outer dimensions	A = B mm	590	540	490	470	440	630	580	530	500	480	660	660	660	660	660	720	720	720	720	720	740	740	740	740	740	790	790	790	790	790	860	860	860	860	860
Centre spacing	$a_c = b_c$ mm	610	555	505	485	460	650	595	545	520	495	680	680	680	680	680	735	735	735	735	735	755	755	755	755	755	805	805	805	805	805	875	875	875	875	875
Edge distance (+ c)	$a_e = b_e$ mm	295	270	245	235	220	315	290	265	250	240	330	330	330	330	330	360	360	360	360	360	370	370	370	370	370	395	395	395	395	395	430	430	430	430	430

1) If smaller, centre spacing and edge distances are required, refer to page 22 for guidance on space reduction. 2) All helix and stirrup reinforcement shall be ribbed reinforcing steel of grade 500 MPa. Grade 460 MPa steel may also be used if one additional stirrup of equivalent size is placed within the same length of the anchorage zone. The indicated stirrup spacings will have to be reduced accordingly. 3) Bar diameter of 14 mm can be replaced by 16 mm. 4) Prestressing strand with nominal diameter of 15,3 mm, cross sectional area of 140 mm² or with characteristic tensile strength below 1,860 MPa may also be used.



Annex – CONA CMI SP



Table 24: CONA CMI SP anchor zone spacing and local reinforcement requirement for strands 06- 150 1860

CONA CMI SP n06		01 06	02 06	03 06	04 06	05 06	06 06	07 06	08 06
Cube strength	f_{cm0} MPa	26 28 34 38 43 46	26 28 34 38 43 46	26 28 34 38 43 46	26 28 34 38 43 46	26 28 34 38 43 46	26 28 34 38 43 46	26 28 34 38 43 46	26 28 34 38 43 46
Cylinder strength	f_{cm0} MPa	21 23 28 31 35 38	21 23 28 31 35 38	21 23 28 31 35 38	21 23 28 31 35 38	21 23 28 31 35 38	21 23 28 31 35 38	21 23 28 31 35 38	21 23 28 31 35 38
Outer diameter	mm	100 100 75 75 75 75	130 130 100 100 100 100	165 160 130 130 120 120	195 190 165 150 145 140	215 200 185 170 160 160	235 230 210 180 175 175	260 255 220 210 195 190	280 270 230 215 205 200
Bar diameter	mm	10 10 10 8 8 8	10 10 10 10 10 10	10 10 10 10 10 10	10 10 10 10 10 10	10 10 10 10 10 10	10 10 12 12 12 12	10 10 12 12 12 12	10 10 12 12 12 12
Pitch	mm	45 45 45 45 45 45	45 45 45 45 45 45	45 45 45 45 45 45	45 45 45 45 45 45	45 45 50 50 50 50	45 45 50 50 50 50	45 45 50 50 50 50	45 45 50 50 50 50
Number of pitches		3 3 2.5 2.5 2.5 2.5	4 4 3.5 3.5 3.5 3.5	4 4 4 4 4 4	5 5 4.5 4.5 4.5 4.5	6 5.5 5 4.5 4.5 4.5	6 5 5 4.5 4.5	6.5 6.5 5.5 5.5 5 5	7 6.5 5.5 5.5 5.5 5
Distance	E mm	20 20 20 20 20 20	20 20 20 20 20 20	20 20 20 20 20 20	25 25 25 25 25 25	30 30 30 30 30 30	35 35 35 35 35 35	35 35 35 35 35 35	35 35 35 35 35 35
Number of STRIRUPS		2 2 2 2 2 2	2 2 3 3 3 2	3 3 6 5 5 5	4 4 5 4 4 4	2 2 5 4 4 4	3 3 2 4 3 3	5 4 5 5 5 4	5 4 3 3 3 3
Bar diameter	mm	6 6 6 6 6 6	6 6 6 6 6 6	10 10 8 8 8 8	10 10 10 10 10 10	12 12 10 10 10 10	12 12 12 12 12 12	12 12 12 12 12 12	12 12 12 12 12 12
Spacing	mm	80 75 70 65 60 60	110 110 60 55 90 90	80 80 30 35 35 35	65 90 45 55 50 50	175 170 50 60 60 80	115 185 70 95 90 90	70 85 60 60 55 70	70 90 120 110 105 100
Distance	F mm	40 40 40 40 40 40	40 40 40 40 40 40	40 40 40 40 40 40	45 45 45 45 45 45	50 50 50 50 50 50	55 55 55 55 55 55	55 55 55 55 55 55	55 55 55 55 55 55
Minimum outer dimensions	A = B mm	100 95 85 80 75 75	150 145 130 125 115 115	185 180 165 155 150 145	215 210 190 180 170 165	245 235 220 205 195 190	270 260 240 225 210 205	295 280 260 250 235 225	315 300 280 265 250 240
Centre spacing	$a_c = b_c$ mm	120 115 105 100 95 95	170 165 150 145 135 135	205 200 185 175 170 165	235 230 210 200 190 185	265 255 240 225 215 210	290 280 260 245 230 225	315 300 280 270 255 245	335 320 300 285 270 260
Edge distance (+ c)	$a_e = b_e$ mm	50 50 45 40 40 40	75 75 65 65 60 60	95 90 85 80 75 75	110 105 95 90 85 85	125 120 110 105 100 95	135 130 120 115 105 105	150 140 130 125 120 115	160 150 140 135 125 120
CONA CMI SP n06		09 06	12 06	13 06	15 06	16 06	19 06	22 06	24 06
Cube strength	f_{cm0} MPa	26 28 34 38 43 46	26 28 34 38 43 46	26 28 34 38 43 46	26 28 34 38 43 46	26 28 34 38 43 46	26 28 34 38 43 46	26 28 34 38 43 46	26 28 34 38 43 46
Cylinder strength	f_{cm0} MPa	21 23 28 31 35 38	21 23 28 31 35 38	21 23 28 31 35 38	21 23 28 31 35 38	21 23 28 31 35 38	21 23 28 31 35 38	21 23 28 31 35 38	21 23 28 31 35 38
Outer diameter	mm	295 280 240 225 215 215	325 320 290 280 270 260	340 330 305 290 280 270	370 350 325 300 290 280	390 370 340 330 310 310	435 410 380 350 340 340	460 430 400 360 350 350	480 460 410 370 360 360
Bar diameter	mm	10 10 10 10 12 12	12 12 12 14 14 14	12 12 12 14 14 14	14 14 14 14 14 14	14 14 14 14 14 14	16 16 16 16 16 16	16 16 16 16 16 16	16 16 16 16 16 16
Pitch	mm	45 45 50 50 50 50	45 45 50 50 50 50	45 45 50 50 50 50	50 50 50 50 50 50	50 50 50 50 50 50	50 50 50 50 50 50	50 50 50 50 50 50	50 50 50 50 50 50
Number of pitches		7 7 6 6 5 5	8 8 7 6.5 6.5 6.5	8.5 8 7 6.5 6.5	8.5 8 7.5 7.5 7	8.5 8.5 8 7.5 7.5 6.5	8.5 8.5 8.5 8 7.5 6.5	9.5 9.5 9 8.5 8 7	10 9.5 9 8.5 7.5 7.5
Distance	E mm	35 35 35 35 35 35	35 35 35 35 35 35	40 40 40 40 40 40	45 45 45 45 45 45	45 45 45 45 45 45	50 50 50 50 45 45	55 55 55 55 55 55	55 55 55 55 55 55
Number of STRIRUPS		5 4 4 4 3 4	7 6 7 6 6 6	7 6 6 6 6 6	7 6 6 6 6 6	7 6 6 6 6 6	7 6 9 8 7 7	7 6 9 8 8 7	7 6 9 8 8 7
Bar diameter	mm	12 12 16 16 16 16	14 14 16 16 16 16	14 14 16 16 16 16	14 14 16 16 16 16	14 14 16 16 16 16	14 16 16 16 16 16	16 16 16 16 16 16	16 16 16 16 16 16
Spacing	mm	75 75 90 85 110 75	55 55 55 60 60 55	65 65 65 60 60 60	70 70 70 70 65 65	70 70 70 65 65 65	80 80 55 55 60 55	80 80 55 60 55 55	90 100 70 70 70 80
Distance	F mm	55 55 55 55 55 55	55 55 55 55 55 55	60 60 60 60 60 60	65 65 65 65 65 65	65 65 65 65 65 65	75 75 75 75 75 75	75 75 75 75 75 75	75 75 75 75 75 75
Minimum outer dimensions	A = B mm	330 320 295 280 265 255	385 375 345 325 310 300	405 390 360 340 320 310	435 420 390 370 350 340	450 435 400 380 360 350	490 470 435 415 395 385	530 510 470 445 425 415	550 530 495 465 445 435
Centre spacing	$a_c = b_c$ mm	355 340 315 300 285 275	410 395 365 345 330 320	425 410 380 360 340 330	455 440 410 390 370 360	470 455 420 400 380 370	510 490 455 435 415 405	550 530 490 465 445 435	575 550 515 485 465 455
Edge distance (+ c)	$a_e = b_e$ mm	170 160 150 140 135 130	195 190 175 165 155 150	205 195 180 170 160 155	220 210 195 185 175 170	225 220 200 190 180 175	245 235 220 210 200 195	265 255 235 225 215 210	280 265 250 235 225 220

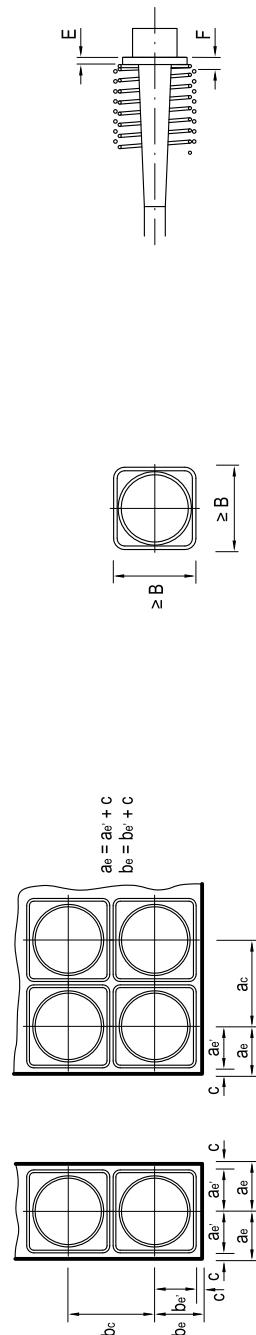

1) If smaller centre spacing and edge distances are required, refer to page 22 for guidance on space reduction. 2) All helix and stirrup reinforcement shall be ribbed reinforcing steel of grade 500 MPa. Grade 460 MPa steel may also be used if one additional stirrup of equivalent size is placed within the same length of the anchorage zone. The indicated stirrup spacings will have to be reduced accordingly. 3) Bar diameter of 14 mm can be replaced by 16 mm. 4) Prestressing strand with nominal diameter of 15.3 mm, cross sectional area of 140 mm² or with characteristic tensile strength below 1,860 MPa may also be used.

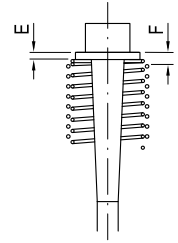
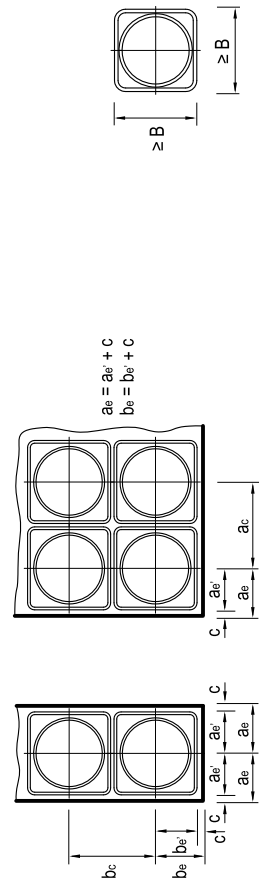

Table 24: CONA CMI SP anchor zone spacing and local reinforcement requirement for strands 06-150 1860 continued

CONA CMI SP n06		25 06	27 06	31 06	37 06	42 06	43 06	48 06	55 06
Cube strength	$f_{cm,0}$ MPa	26 28 34 38 43 46	26 28 34 38 43 46	26 28 34 38 43 46	26 28 34 38 43 46	26 28 34 38 43 46	26 28 34 38 43 46	26 28 34 38 43 46	26 28 34 38 43 46
Cylinder strength	$f_{cm,0}$ MPa	21 23 28 31 35 38	21 23 28 31 35 38	21 23 28 31 35 38	21 23 28 31 35 38	21 23 28 31 35 38	21 23 28 31 35 38	21 23 28 31 35 38	21 23 28 31 35 38
Outer diameter HELIX	mm	500 480 420 380 370 370	520 500 450 400 390 380	560 540 480 430 430	620 620 620 620 620 620	660 660 660 660 660 660	670 670 670 670 670 670	720 720 720 720 720 720	790 790 790 790 790 790
Bar diameter	mm	16 16 16 16 16 16	16 16 16 16 16 16	16 16 16 16 16 16	16 16 16 16 16 16	16 16 16 16 16 16	16 16 16 16 16 16	20 20 20 20 20 20	25 25 25 25 25 25
Pitch	mm	50 50 50 50 50 50	50 50 50 50 50 50	50 50 50 50 50 50	50 50 50 50 50 50	50 50 50 50 50 50	50 50 50 50 50 50	60 60 60 60 60 60	70 70 70 70 70 70
Number of pitches		10 10 9.5 9.5 8.5 8	10.5 10.5 9.5 9.5 9 8.5	11 11 10 10 9 8.5	12 12 12 12 12 12	13 13 13 13 13 13	14 14 14 14 14 14	15 15 15 15 15 15	14 14 14 14 14 14
Distance	E mm	60 60 60 60 60 60	60 60 60 60 60 60	60 60 60 60 60 60	70 70 70 70 70 70	75 75 75 75 75 75	75 75 75 75 75 75	80 80 80 80 80 80	90 90 90 90 90 90
Number of STRIRUPS		7 6 9 8 8 6	6 5 7 6 6 6	8 7 10 9 8 8	11 11 11 11 11 11	11 11 11 11 11 11	11 11 11 11 11 11	11 11 11 11 11 11	12 12 12 12 12 12
Bar diameter	mm	20 20 20 20 20 20	20 20 20 20 20 20	20 20 20 20 20 20	20 20 20 20 20 20	20 20 20 20 20 20	20 20 20 20 20 20	20 20 20 20 20 20	16 16 16 16 16 16
Spacing	mm	100 100 70 70 80 80	100 100 80 90 85 70	80 95 60 65 70 65	75 75 75 75 75 75	75 75 75 75 75 75	75 75 75 75 75 75	75 75 75 75 75 75	70 70 70 70 70 70
Distance	F mm	80 80 80 80 80 80	80 80 80 80 80 80	80 80 80 80 80 80	90 90 90 90 90 90	95 95 95 95 95 95	95 95 95 95 95 95	100 100 100 100 100 100	110 110 110 110 110 110
Minimum outer dimensions	A = B mm	565 545 500 475 450 440	585 565 520 495 470 460	630 605 560 535 515 500	695	745	755	810	885
Centre spacing	$a_c = b_c$ mm	585 565 520 495 470 460	605 585 540 515 490 480	650 625 580 555 535 520	715	765	775	830	905
Edge distance (+ c)	$a_e = b_e$ mm	285 275 250 240 225 220	295 285 260 250 235 230	315 305 280 270 260 250	350	375	380	405	445

CONA CMI SP n06		61 06	69 06	73 06
Cube strength	$f_{cm,0}$ MPa	26 28 34 38 43 46	26 28 34 38 43 46	26 28 34 38 43 46
Cylinder strength	$f_{cm,0}$ MPa	21 23 28 31 35 38	21 23 28 31 35 38	21 23 28 31 35 38
Outer diameter HELIX	mm	860 860 860 860 860 860	920 920 920 920 920 920	960 960 960 960 960 960
Bar diameter	mm	25 25 25 25 25 25	25 25 25 25 25 25	25 25 25 25 25 25
Pitch	mm	60 60 60 60 60 60	60 60 60 60 60 60	60 60 60 60 60 60
Number of pitches		17 17 17 17 17 17	19 19 19 19 19 19	20 20 20 20 20 20
Distance	E mm	90 90 90 90 90 90	100 100 100 100 100 100	110 110 110 110 110 110
Number of STRIRUPS		13 13 13 13 13 13	12 12 12 12 12 12	13 13 13 13 13 13
Bar diameter	mm	16 16 16 16 16 16	20 20 20 20 20 20	20 20 20 20 20 20
Spacing	mm	70 70 70 70 70 70	85 85 85 85 85 85	85 85 85 85 85 85
Distance	F mm	110 110 110 110 110 110	120 120 120 120 120 120	130 130 130 130 130 130
Minimum outer dimensions	A = B mm	940	1020	1060
Centre spacing	$a_c = b_c$ mm	960	1040	1080
Edge distance (+ c)	$a_e = b_e$ mm	470	510	530

1) If smaller centre spacing and edge distances are required, refer to page 22 for guidance on space reduction. 2) All helix and stirrup reinforcement shall be ribbed reinforcing steel of grade 500 MPa. Grade 460 MPa steel may also be used if one additional stirrup of equivalent size is placed within the same length of the anchorage zone. The indicated stirrup spacings will have to be reduced accordingly. 3) Bar diameter of 14 mm can be replaced by 16 mm. 4) Prestressing strand with nominal diameter of 15,3 mm, cross sectional area of 140 mm² or with characteristic tensile strength below 1,860 MPa may also be used.



Annex – CONA CME BT/SP

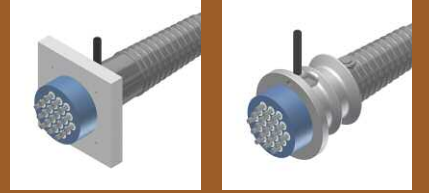

CONA CME anchorage and couple configurations

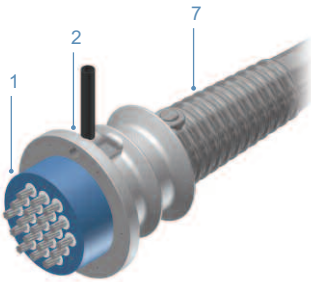

CONA CME BT Anchorage

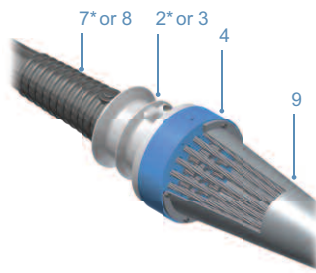

CONA CME Coupler K

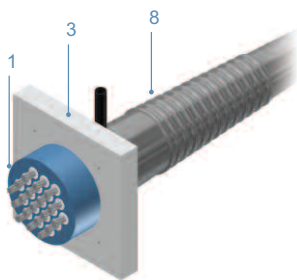

CONA CME SP Anchorage

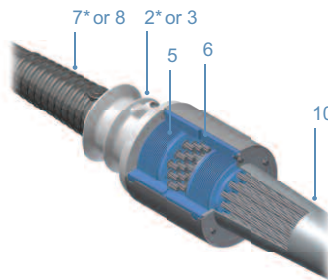

CONA CME Coupler H

- 1 – Anchor head
- 2 – Bearing trumplate
- 3 – Square plate
- 4 – Coupler head type K
- 5 – Coupler head type H
- 6 – Coupler sleeve type H
- 7 – Trumpet type A
- 8 – Trumpet type A SP
- 9 – Trumpet type CME-K
- 10 – Trumpet type CME-H
- * – Shown

CONA CME minimum radii of curvature

The minimum radii of curvature (R_{min}), eccentricity (e), inner duct diameter (d_i), and minimum duct wall thickness (t_{min}) given in Tables 26 and 27 correspond to a prestressing force of the tendon of $0.85 F_{p0,1}$, a diameter of the strands of 15.3 mm (06-140 1860) or 15.7 mm (06-150 1860) and an allowable contact pressure of 350 kN/m. The given duct diameters result in degrees of filling which are in the range of 0.25 to 0.35, suitable for long tendons with minimum radii of curvature. A higher degree of filling of up to $f = 0.45$, is possible

for shorter tendons and bigger radii of curvature. The standard ratio wall thickness to outside diameter should not be smaller than $1/25$ and minimum 3.0 mm for plastic ducts and $1/65$ or minimum 1.5 mm for steel ducts.

In the following two tables common sizes for steel ducts are shown. Most common diameters are underlined.

For minimum radius of curvature tables using a wax filler, please refer to the BBRVT CONA CME European Technical Approval.

Annex – CONA CME BT/SP

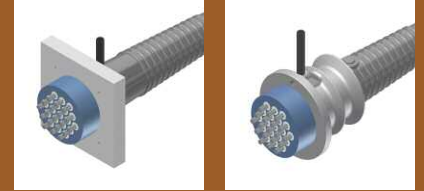

Table 26: CONA CME minimum radii of curvature for strands 06-140 1860 and $p_{R,max} = 350 \text{ kN/m}$

Type of Duct n 06 Number of strands	Plastic Duct					Plastic Duct $\approx 1.5 \cdot R_{min}$					Steel Duct				
	d_i mm	t_{min} mm	R_{min} m	e mm	f -	d_i mm	t_{min} mm	R_{min} m	e mm	f -	d_o mm	t mm	R_{min} m	e mm	f -
01 06	30	3.0	2.0	8	0.20	20	3.0	2.0	3	0.45	33.7	2.6	2.0	6.6	0.22
02 06	40	3.0	2.0	10	0.22	35	3.0	2.0	6	0.29	42.4	2.6	2.0	10	0.26
03 06	45	3.0	2.0	10	0.26	35	3.0	2.0	2	0.44	48.3	2.6	2.0	10	0.29
04 06	55	3.0	2.0	13	0.24	40	3.0	2.0	3	0.45	60.3	2.9	2.0	13	0.24
05 06	60	3.0	2.0	15	0.25	45	3.0	2.1	4	0.44	63.5	2.9	2.0	14	0.27
06 06	65	3.0	2.0	15	0.25	50	3.0	2.4	6	0.43	70	2.9	2.0	15	0.26
07 06	70	3.0	2.0	17	0.25	55	3.0	2.6	7	0.41	76.1	2.9	2.0	17	0.25
08 06	75	3.0	2.0	18	0.25	55	3.0	2.7	4	0.47	82.5	3.2	2.0	18	0.25
09 06	80	3.2	2.0	20	0.25	60	3.0	2.9	6	0.45	82.5	3.2	2.0	19	0.28
12 06	90	3.6	2.3	21	0.26	70	3.0	3.4	8	0.44	95	3.6	2.3	21	0.28
13 06	95	3.8	2.3	23	0.26	70	3.0	3.5	6	0.47	101.6	3.6	2.3	23	0.26
15 06	105	4.2	2.4	27	0.24	75	3.0	3.6	7	0.48	108	3.6	2.5	26	0.26
16 06	105	4.2	2.6	26	0.26	80	3.2	3.9	9	0.45	114.3	3.6	2.5	26	0.25
19 06	115	4.6	2.8	28	0.26	85	3.4	4.2	8	0.47	121	4	2.9	28	0.27
22 06	125	5.0	3.0	31	0.25	95	3.8	4.5	11	0.43	133	4	3.0	31	0.25
24 06	130	5.2	3.1	32	0.25	100	4.0	4.7	12	0.43	139.7	4	3.1	32	0.25
25 06	135	5.4	3.2	34	0.24	100	4.0	4.7	11	0.45	139.7	4	3.2	33	0.26
27 06	140	5.6	3.3	36	0.25	105	4.2	4.9	13	0.44	139.7	4	3.5	35	0.28
31 06	150	6.0	3.5	38	0.25	110	4.4	5.3	12	0.46	152.4	4.5	3.7	37	0.27
37 06	160	6.4	3.9	39	0.26	120	4.8	5.9	13	0.46	165.1	4.5	4.0	38	0.27
42 06	175	7.0	4.1	39	0.24	130	5.2	6.1	15	0.44	177.8	5	4.3	39	0.27
43 06	175	7.0	4.2	40	0.25	130	5.2	6.3	16	0.45	177.8	5	4.4	39	0.27
48 06	185	7.4	4.4	41	0.25	140	5.6	6.6	17	0.44	193.7	5.6	4.5	40	0.26
55 06	200	8.0	4.7	45	0.25	145	5.8	7.0	18	0.47	193.7	5.6	5.1	44	0.29
61 06	210	8.4	4.9	50	0.25	155	6.2	7.4	18	0.45	219.1	6.3	5.0	49	0.25
69 06	220	8.8	5.3	54	0.25	165	6.6	8.0	19	0.45	219.1	6.3	5.7	52	0.29
73 06	230	9.2	5.4	59	0.25	170	6.8	8.1	20	0.45	219.1	6.3	6.0	55	0.31

Table 27: CONA CME minimum radii of curvature for strands 06-150 1860 and $p_{R,max} = 350 \text{ kN/m}$

Type of Duct n 06 Number of strands	Plastic Duct					Plastic Duct $\approx 1.5 \cdot R_{min}$					Steel Duct				
	d_i mm	t_{min} mm	R_{min} m	e mm	f -	d_i mm	t_{min} mm	R_{min} m	e mm	f -	d_o mm	t mm	R_{min} m	e mm	f -
01 06	30	3.0	2.0	7	0.21	25	3.0	2.0	5	0.31	33.7	2.6	2.0	7	0.24
02 06	40	3.0	2.0	9	0.24	35	3.0	2.0	6	0.31	42.4	2.6	2.0	8	0.28
03 06	45	3.0	2.0	9	0.28	35	3.0	2.0	2	0.47	48.3	2.6	2.0	8	0.31
04 06	55	3.0	2.0	13	0.25	45	3.0	2.0	3	0.38	60.3	2.9	2.0	12	0.26
05 06	60	3.0	2.0	14	0.27	45	3.0	2.3	3	0.47	63.5	2.9	2.0	13	0.29
06 06	65	3.0	2.0	15	0.27	50	3.0	2.6	5	0.46	70	2.9	2.0	14	0.28
07 06	70	3.0	2.0	19	0.27	55	3.0	2.8	6	0.44	76.1	2.9	2.0	19	0.27
08 06	75	3.0	2.0	20	0.27	60	3.0	3.0	7	0.42	82.5	3.2	2.0	21	0.26
09 06	80	3.2	2.1	22	0.27	65	3.0	3.2	5	0.41	88.5	3.2	2.1	23	0.26
12 06	90	3.6	2.5	23	0.28	70	3.0	3.8	7	0.47	95	3.6	2.6	22	0.30
13 06	95	3.8	2.6	25	0.28	75	3.0	3.9	9	0.44	101.6	3.6	2.6	25	0.28
15 06	105	4.2	2.7	25	0.26	80	3.2	4.0	9	0.45	114.3	3.6	2.6	26	0.25
16 06	105	4.2	2.9	28	0.28	85	3.4	4.3	10	0.42	114.3	3.6	2.8	29	0.27
19 06	115	4.6	3.1	30	0.27	90	3.6	4.6	10	0.45	121	4	3.2	29	0.28
22 06	125	5.0	3.3	33	0.27	95	3.8	5.0	10	0.47	133	4	3.3	33	0.27
24 06	130	5.2	3.5	34	0.27	100	4.0	5.2	11	0.46	139.7	4	3.4	35	0.26
25 06	135	5.4	3.5	36	0.26	105	4.2	5.2	14	0.43	139.7	4	3.6	35	0.28
27 06	140	5.6	3.6	38	0.26	110	4.4	5.4	11	0.43	152.4	4.5	3.5	39	0.25
31 06	150	6.0	3.9	40	0.26	115	4.6	5.8	14	0.45	159	4.5	3.9	40	0.26
37 06	165	6.6	4.2	41	0.26	125	5.0	6.3	15	0.45	177.8	5	4.1	42	0.25
42 06	180	7.2	4.4	42	0.25	135	5.4	6.6	17	0.44	193.7	5.6	4.3	43	0.24
43 06	180	7.2	4.5	43	0.25	135	5.4	6.7	19	0.45	193.7	5.6	4.4	44	0.25
48 06	190	7.6	4.7	44	0.25	145	5.8	7.1	21	0.44	193.7	5.6	4.9	43	0.28
55 06	205	8.2	5.0	47	0.25	155	6.2	7.5	21	0.44	219.1	6.3	5.0	47	0.25
61 06	215	8.6	5.3	50	0.25	160	6.4	8.0	22	0.46	219.1	6.3	5.5	48	0.27
69 06	225	9.0	5.8	53	0.26	170	6.8	8.6	23	0.46	244.5	6.3	5.6	54	0.25
73 06	235	9.4	5.8	56	0.25	175	7.0	8.7	23	0.46	244.5	6.3	5.9	53	0.26

Annex – CONA CME BT



Table 28: CONA CME BT anchor zone spacing and local reinforcement requirement for strands 06-150 1860

CONA CME BT n06		02 06	03 06	04 06	05 06	06 06	07 06	08 06	09 06
Cube strength	f_{cm0} MPa	23 28 34 38 43	23 28 34 38 43	23 28 34 38 43	23 28 34 38 43	23 28 34 38 43	23 28 34 38 43	23 28 34 38 43	23 28 34 38 43
Cylinder strength	f_{cm0} MPa	19 23 28 31 35	19 23 28 31 35	19 23 28 31 35	19 23 28 31 35	19 23 28 31 35	19 23 28 31 35	19 23 28 31 35	19 23 28 31 35
Outer diameter HELIX	mm	160 160 160 160 155	160 160 160 160 155	180 160 160 160 160	200 195 195 195 195	200 200 195 195 195	230 200 200 200 200	270 230 225 220 220	280 260 255 250 250
Bar diameter	mm	10 10 10 10 10	10 10 10 10 10	10 10 10 10 10	10 10 10 10 10	10 10 10 10 10	12 12 12 12 12	14 12 12 12 12	14 12 12 12 12
Pitch	mm	45 45 45 45 45	45 45 45 45 45	45 45 45 45 45	45 50 50 60 50	45 50 50 60 50	45 50 50 50 50	50 50 50 50 50	50 50 50 50 50
Number of pitches		5 5 5 5 5	5 5 5 5 5	5 5 5 5 5	6 5 5 5 5	6 5 5 5 5	6 6 5 5 5	6 6 5 6 6	6 6 6 6 6
Distance	E mm	15 15 15 15 15	15 15 15 15 15	15 15 15 15 15	18 18 18 18 18	18 18 18 18 18	18 18 18 18 18	20 20 20 20 20	20 20 20 20 20
Number of STRIRUPS		3 3 3 3 3	3 3 3 3 3	3 3 3 3 3	4 4 4 4 4	4 4 4 4 4	4 4 4 4 4	4 4 4 4 4	4 4 4 4 4
Bar diameter	mm	8 8 8 8 8	8 8 8 8 8	10 10 10 10 10	12 12 12 12 12	12 12 12 12 12	14 14 14 14 14	14 12 12 14 14	12 12 12 14 14
Spacing	mm	55 55 55 55 55	45 55 45 55 45	55 55 45 55 45	55 50 50 65 50	55 55 45 65 55	55 60 55 55 55	70 45 50 55 50	60 55 55 60 55
Distance	F mm	30 30 30 30 30	30 30 30 30 30	30 30 30 30 30	33 33 33 33 33	33 33 33 33 33	33 33 33 33 33	33 33 33 33 33	33 33 33 33 33
Minimum outer dimensions	A = B mm	190 190 190 190 190	190 190 190 190 190	220 200 190 190 190	250 230 230 230 230	270 250 230 230 230	290 270 240 240 240	310 290 260 260 260	330 300 290 290 290
Centre spacing	$a_c = b_c$ mm	210 210 210 210 205	210 210 210 210 205	235 215 210 210 205	265 250 250 250 250	290 265 250 250 250	310 285 260 255 255	330 305 280 275 275	350 320 310 310 310
Edge distance (+ c)	$a_e = b_e$ mm	95 95 95 95 95	95 95 95 95 95	110 100 95 95 95	125 115 115 115 115	135 125 115 115 115	145 135 120 120 120	155 145 130 130 130	165 150 145 145 145
CONA CME BT n06		12 06	13 06	15 06	16 06	19 06	22 06	24 06	25 06
Cube strength	f_{cm0} MPa	23 28 34 38 43	23 28 34 38 43	23 28 34 38 43	23 28 34 38 43	23 28 34 38 43	23 28 34 38 43	23 28 34 38 43	23 28 34 38 43
Cylinder strength	f_{cm0} MPa	19 23 28 31 35	19 23 28 31 35	19 23 28 31 35	19 23 28 31 35	19 23 28 31 35	19 23 28 31 35	19 23 28 31 35	19 23 28 31 35
Outer diameter HELIX	mm	330 280 275 260 250	375 330 300 280 270	375 330 315 305 305	375 330 320 310 305	420 360 360 330 325	475 420 390 360 340	475 430 410 360 360	520 430 420 390 380
Bar diameter	mm	14 14 14 14 14	14 14 14 14 14	14 14 14 14 14	14 14 14 14 14	14 14 14 14 14	14 14 14 14 14	14 14 14 14 14	14 14 14 14 14
Pitch	mm	50 50 50 50 50	50 50 50 50 50	50 50 50 50 50	50 50 50 50 50	50 50 50 50 50	50 50 50 50 50	50 50 50 50 50	50 50 50 50 50
Number of pitches		7 7 7 7 6	8 8 8 7 6	9 9 8 7 7	9 9 9 8 7	9 9 10 9 9	10 10 9 9 8	11 11 10 10 9	11 11 10 10 9
Distance	E mm	20 20 20 20 20	23 23 23 23 23	27 27 27 27 27	27 27 27 27 27	27 27 27 27 27	31 31 31 31 31	32 32 32 32 32	35 35 35 35 35
Number of STRIRUPS		7 6 5 5 6	7 6 6 6 7	7 6 5 6 5	7 6 5 6 6	7 7 7 7 7	7 6 7 8 7	7 7 7 7 8	7 6 7 7 7
Bar diameter	mm	12 14 16 16 14	12 14 14 14 14	14 16 16 16 16	14 16 16 16 16	16 16 16 16 16	20 20 20 20 20	20 20 20 20 20	20 20 20 20 20
Spacing	mm	60 55 70 50 50	55 60 55 60 45	60 65 65 55 60	60 65 65 60 60	65 65 65 60 60	80 75 65 65 65	80 80 70 65 55	80 90 70 60 60
Distance	F mm	35 35 35 35 35	40 40 40 40 40	42 42 42 42 42	42 42 42 42 42	42 42 42 42 42	46 46 46 46 46	47 47 47 47 47	50 50 50 50 50
Minimum outer dimensions	A = B mm	390 350 320 310 290	410 370 340 320 310	440 400 360 350 350	450 410 370 360 350	490 450 410 390 370	530 480 440 420 400	560 510 460 440 420	570 520 470 450 430
Centre spacing	$a_c = b_c$ mm	405 370 340 325 310	425 390 355 340 325	455 415 380 365 365	470 430 390 375 365	510 465 425 410 390	550 500 460 440 420	575 525 480 460 435	590 535 485 465 450
Edge distance (+ c)	$a_e = b_e$ mm	195 175 160 155 145	205 185 170 160 155	220 200 180 175 175	225 205 185 180 175	245 225 205 195 185	265 240 220 210 200	280 255 230 220 210	285 260 235 225 215

1) If smaller centre spacing and edge distances are required, refer to page 22 for guidance on space reduction. 2) All helix and stirrup reinforcement shall be ribbed reinforcing steel of grade 500 MPa. Grade 460 MPa steel may also be used if one additional stirrup of equivalent size is placed within the same length of the anchorage zone. The indicated stirrup spacings will have to be reduced accordingly. 3) Bar diameter of 14 mm can be replaced by 16 mm. 4) Prestressing strand with nominal diameter of 15,3 mm, cross sectional area of 140 mm² or with characteristic tensile strength below 1860 MPa may also be used.

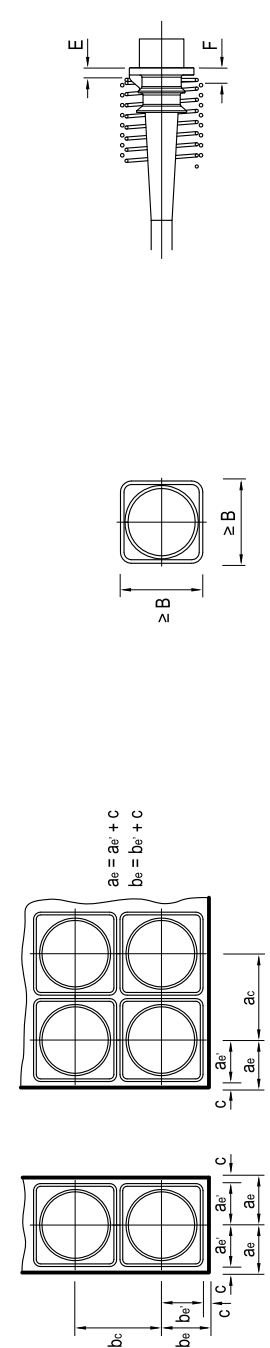

Annex – CONA CME BT



Table 28: CONA CME BT anchor zone spacing and local reinforcement requirement for strands 06-150 1860 continued

CONA CME BT n06	27 06			31 06			37 06			42 06			43 06			48 06			55 06			61 06																	
	23	28	34	38	43	23	28	34	38	43	23	28	34	38	43	19	23	28	31	35	19	23	28	31	35	19	23	28	31	35	19	23	28	31	35	19	23	28	31
Cube strength	MPa																																						
Cylinder strength	MPa																																						
Outer diameter	mm																																						
Bar diameter	mm																																						
Pitch	mm																																						
Number of pitches																																							
Distance	E mm																																						
Number of STIRRUPS																																							
Bar diameter	mm																																						
Spacing	mm																																						
Distance	F mm																																						
Minimum outer dimensions	A = B mm																																						
Centre spacing	mm																																						
Edge distance (+ c)	mm																																						

1) If smaller, centre spacing and edge distances are required, refer to page 22 for guidance on space reduction. 2) All helix and stirrup reinforcement shall be ribbed reinforcing steel of grade 500 MPa. Grade 460 MPa steel may also be used if one additional stirrup of equivalent size is placed within the same length of the anchorage zone. The indicated stirrup spacings will have to be reduced accordingly. 3) Bar diameter of 14 mm can be replaced by 16 mm. 4) Prestressing strand with nominal diameter of 15,3 mm, cross sectional area of 140 mm² or with characteristic tensile strength below 1,860 MPa may also be used.

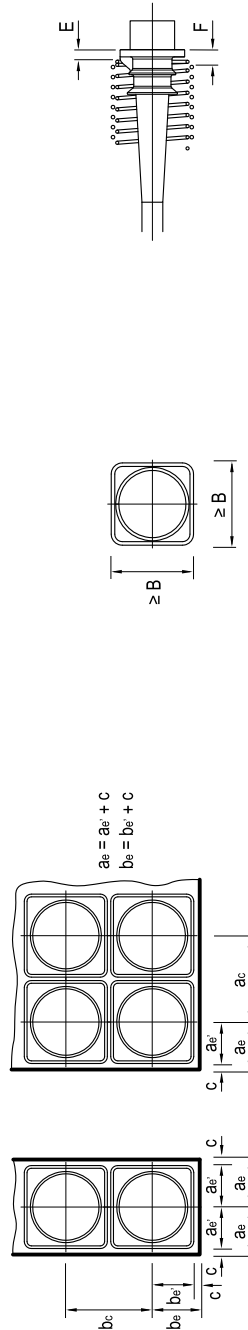
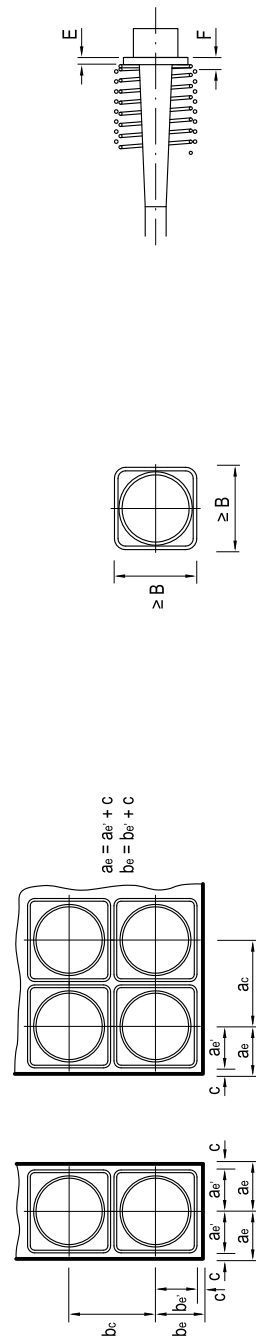



Table 29: CONA CME SP anchor zone spacing and local reinforcement requirement for strands 06-150 1860

CONA CME SP n06		01 06	02 06	03 06	04 06	05 06	06 06	07 06	08 06
Cube strength	$f_{cm,0}$ MPa	26 28 34 38 43 46	26 28 34 38 43 46	26 28 34 38 43 46	26 28 34 38 43 46	26 28 34 38 43 46	26 28 34 38 43 46	26 28 34 38 43 46	26 28 34 38 43 46
Cylinder strength	$f_{cm,0}$ MPa	21 23 28 31 35 38	21 23 28 31 35 38	21 23 28 31 35 38	21 23 28 31 35 38	21 23 28 31 35 38	21 23 28 31 35 38	21 23 28 31 35 38	21 23 28 31 35 38
Outer diameter HELIX	mm	100 100 75 75 75 75	130 130 100 100 100 100	165 160 130 130 120 120	195 190 165 150 145 140	215 200 185 170 160 160	235 230 210 180 175 175	260 255 220 210 195 190	280 270 230 215 205 200
Bar diameter	mm	10 10 10 8 8 8	10 10 10 10 10 10	10 10 10 10 10 10	10 10 10 10 10 10	10 10 10 10 10 10	10 10 12 12 12 12	10 10 12 12 12 12	10 10 12 12 12 12
Pitch	mm	45 45 45 45 45 45	45 45 45 45 45 45	45 45 45 45 45 45	45 45 45 45 45 45	45 50 50 50 50 50	45 50 50 50 50 50	45 50 50 50 50 50	45 50 50 50 50 50
Number of pitches		3 3 2,5 2,5 2,5 2,5	4 4 3,5 3,5 3,5 3,5	4 4 4 4 4 4	5 5 4,5 4,5 4,5 4,5	6 6 5,5 5 4,5 4,5 4,5	6 6 5 4,5 4,5 4,5 4,5	6,5 6,5 5,5 5,5 5,5 5,5	7 6,5 5,5 5,5 5,5 5,5
Distance	E mm	20 20 20 20 20 20	20 20 20 20 20 20	20 20 20 20 20 20	25 25 25 25 25 25	30 30 30 30 30 30	35 35 35 35 35 35	35 35 35 35 35 35	35 35 35 35 35 35
Number of STRIRUPS		2 2 2 2 2 2	2 2 3 3 3 2	3 3 6 5 5 4	4 4 5 4 4 4	4 4 5 4 4 4	4 4 5 4 4 4	4 4 5 4 4 4	4 4 5 4 4 4
Bar diameter	mm	6 6 6 6 6 6	6 6 6 6 6 6	10 10 8 8 8 8	10 10 10 10 10 10	10 10 10 10 10 10	12 12 10 10 10 12	12 12 12 12 12 12	12 12 12 12 12 12
Spacing	mm	80 75 70 65 60 60	110 110 60 55 90 90	80 80 30 35 35 35	65 90 45 55 50 50	175 170 50 60 60 80	115 185 70 95 90 90	70 85 60 60 55 70	90 120 110 105 100 100
Distance	F mm	40 40 40 40 40 40	40 40 40 40 40 40	40 40 40 40 40 40	45 45 45 45 45 45	50 50 50 50 50 50	55 55 55 55 55 55	55 55 55 55 55 55	55 55 55 55 55 55
Minimum outer dimensions	A = B mm	100 95 85 80 75 75	150 145 130 125 115 115	185 180 165 155 150 145	215 210 190 180 170 165	245 235 220 205 195 190	270 260 240 225 210 205	295 280 260 250 235 225	315 300 280 265 250 240
Centre spacing	$a_c = b_c$ mm	120 115 105 100 95 95	170 165 150 145 135 135	205 200 185 175 170 165	235 230 210 200 190 185	265 255 240 225 215 210	290 280 260 245 230 225	315 300 280 270 255 245	335 320 300 285 270 260
Edge distance (+ c)	$a_e = b_e$ mm	50 50 45 40 40 40	75 75 65 60 60 60	95 90 85 80 75 75	110 105 95 90 85 85	125 120 110 105 100 95	135 130 120 115 105 105	150 140 130 125 120 115	160 150 140 135 125 120
CONA CME SP n06		09 06	12 06	13 06	15 06	16 06	19 06	22 06	24 06
Cube strength	$f_{cm,0}$ MPa	26 28 34 38 43 46	26 28 34 38 43 46	26 28 34 38 43 46	26 28 34 38 43 46	26 28 34 38 43 46	26 28 34 38 43 46	26 28 34 38 43 46	26 28 34 38 43 46
Cylinder strength	$f_{cm,0}$ MPa	21 23 28 31 35 38	21 23 28 31 35 38	21 23 28 31 35 38	21 23 28 31 35 38	21 23 28 31 35 38	21 23 28 31 35 38	21 23 28 31 35 38	21 23 28 31 35 38
Outer diameter HELIX	mm	295 280 240 225 215 215	325 320 290 280 270 260	340 330 305 290 280 270	370 350 325 300 290 280	390 370 340 330 310 310	435 410 380 350 340 340	460 430 400 360 350 350	480 460 410 370 360 360
Bar diameter	mm	10 10 10 10 12 12	12 12 12 14 14 14	12 12 12 14 14 14	14 14 14 14 14 14	14 14 14 14 14 14	16 16 16 16 16 16	16 16 16 16 16 16	16 16 16 16 16 16
Pitch	mm	45 50 50 50 50 50	45 50 50 50 50 50	45 45 50 50 50 50	50 50 50 50 50 50	50 50 50 50 50 50	50 50 50 50 50 50	50 50 50 50 50 50	50 50 50 50 50 50
Number of pitches		7 7 6 6 5 5	8 8 7 6,5 6,5 5,5	8,5 8 7 6,5 6	8,5 8 7,5 7,5 7	8,5 8,5 8 7,5 7,5 6,5	8,5 8,5 8 7,5 6,5 6,5	9,5 9,5 9 8,5 8 7	10 9,5 9 9 8,5 7,5
Distance	E mm	35 35 35 35 35 35	35 35 35 35 35 35	40 40 40 40 40 40	45 45 45 45 45 45	45 45 45 45 45 45	45 45 45 45 45 45	55 55 55 55 55 55	55 55 55 55 55 55
Number of STRIRUPS		5 4 4 4 3 4	7 6 7 6 6 6	7 6 6 6 6 6	7 6 6 6 6 6	7 6 6 6 6 6	7 6 6 6 6 6	7 6 6 6 6 6	7 6 6 6 6 6
Bar diameter	mm	12 12 16 16 16 16	14 14 16 16 16 16	14 14 16 16 16 16	14 14 16 16 16 16	14 14 16 16 16 16	14 16 16 16 16 16	16 16 16 16 16 16	16 16 16 16 16 16
Spacing	mm	75 75 90 85 110 75	55 55 55 60 60 55	65 65 65 60 60 60	70 70 70 70 65 65	70 70 60 70 65 65	70 85 50 55 60 55	80 80 55 60 55 55	90 100 70 70 70 80
Distance	F mm	55 55 55 55 55 55	55 55 55 55 55 55	60 60 60 60 60 60	65 65 65 65 65 65	65 65 65 65 65 65	75 75 75 75 75 75	75 75 75 75 75 75	75 75 75 75 75 75
Minimum outer dimensions	A = B mm	330 320 295 280 265 255	385 375 345 325 310 300	405 390 360 340 320 310	435 420 390 370 350 340	450 435 400 380 360 350	490 470 435 415 395 385	530 510 470 445 425 415	550 530 495 465 445 435
Centre spacing	$a_c = b_c$ mm	355 340 315 300 285 275	410 395 365 345 330 320	425 410 380 360 340 330	455 440 410 390 370 360	470 455 420 400 380 370	510 490 455 435 415 405	550 530 490 465 445 435	575 550 515 485 465 455
Edge distance (+ c)	$a_e = b_e$ mm	170 160 150 140 135 130	195 190 175 165 155 150	205 195 180 170 160 155	220 210 195 185 175 170	225 220 200 190 180 175	245 235 220 210 200 195	265 255 235 225 215 210	280 265 250 235 225 220

1) If smaller centre spacing and edge distances are required, refer to page 22 for guidance on space reduction. 2) All helix and stirrup reinforcement shall be ribbed reinforcing steel of grade 500 MPa. Grade 460 MPa steel may also be used if one additional stirrup of equivalent size is placed within the same length of the anchorage zone. The indicated stirrup spacings will have to be reduced accordingly. 3) Bar diameter of 14 mm can be replaced by 16 mm. 4) Prestressing strand with nominal diameter of 15,3 mm, cross sectional area of 140 mm² or with characteristic tensile strength below 1860 MPa may also be used.



Annex – CONA CME SP

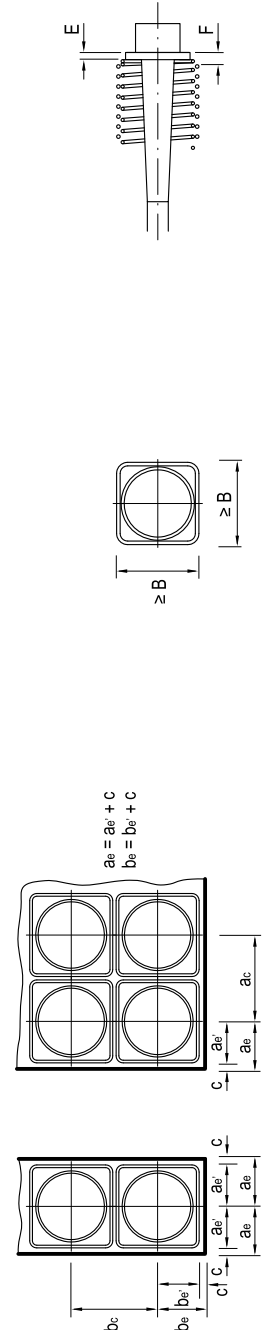

Table 29: CONA CME SP anchor zone spacing and local reinforcement requirement for strands 06-150 1860 continued

CONA CME SP n06		25 06	27 06	31 06	37 06	42 06	43 06	48 06	55 06
Cube strength	$f_{cm,0}$ MPa	26 28 34 38 43 46	26 28 34 38 43 46	26 28 34 38 43 46	26 28 34 38 43 46	26 28 34 38 43 46	26 28 34 38 43 46	26 28 34 38 43 46	26 28 34 38 43 46
Cylinder strength	$f_{cm,0}$ MPa	21 23 28 31 35 38	21 23 28 31 35 38	21 23 28 31 35 38	21 23 28 31 35 38	21 23 28 31 35 38	21 23 28 31 35 38	21 23 28 31 35 38	21 23 28 31 35 38
Outer diameter	mm	500 480 420 380 370 370	520 500 450 400 390 380	560 540 480 430 430	620 620 620 620 620 620	660 660 660 660 660 660	670 670 670 670 670 670	720 720 720 720 720 720	790 790 790 790 790 790
Bar diameter	mm	16 16 16 16 16 16	16 16 16 16 16 16	16 16 16 16 16 16	16 16 16 16 16 16	16 16 16 16 16 16	16 16 16 16 16 16	16 16 16 16 16 16	16 16 16 16 16 16
Pitch	mm	50 50 50 50 50 50	50 50 50 50 50 50	50 50 50 50 50 50	50 50 50 50 50 50	50 50 50 50 50 50	50 50 50 50 50 50	60 60 60 60 60 60	70 70 70 70 70 70
Number of pitches		10 10 9.5 8.5 8	10.5 10.5 9.5 9.5 9 8.5	11 11 10 10 9 8.5	12 12 12 12 12 12	13 13 13 13 13 13	14 14 14 14 14 14	15 15 15 15 15 15	14 14 14 14 14 14
Distance	E mm	60 60 60 60 60 60	60 60 60 60 60 60	60 60 60 60 60 60	70 70 70 70 70 70	75 75 75 75 75 75	75 75 75 75 75 75	80 80 80 80 80 80	90 90 90 90 90 90
Number of STIRRUPS		7 6 9 8 8 6	6 5 7 6 6 6	8 7 10 9 8 8	11 11 11 11 11 11	11 11 11 11 11 11	11 11 11 11 11 11	11 11 11 11 11 11	12 12 12 12 12 12
Bar diameter	mm	20 20 20 20 20 20	20 20 20 20 20 20	20 20 20 20 20 20	20 20 20 20 20 20	20 20 20 20 20 20	20 20 20 20 20 20	20 20 20 20 20 20	16 16 16 16 16 16
Spacing	mm	100 100 70 70 80	100 100 80 90 85 70	80 95 60 65 70 65	75 75 75 75 75 75	75 75 75 75 75 75	75 75 75 75 75 75	75 75 75 75 75 75	70 70 70 70 70 70
Distance	F mm	80 80 80 80 80	80 80 80 80 80 80	80 80 80 80 80 80	90 90 90 90 90 90	95 95 95 95 95 95	95 95 95 95 95 95	100 100 100 100 100 100	110 110 110 110 110 110
Minimum outer dimensions	A = B mm	565 545 500 475 450 440	585 565 520 495 470 460	630 605 560 535 515 500	695	745	755	810	885
Centre spacing	$a_c = b_c$ mm	585 565 520 495 470 460	605 585 540 515 490 480	650 625 580 555 535 520	715	765	775	830	905
Edge distance (+ c)	$a_e = b_e$ mm	285 275 250 240 225 220	295 285 260 250 235 230	315 305 280 270 260 250	350	375	380	405	445

CONA CME SP n06		61 06	69 06	73 06
Cube strength	$f_{cm,0}$ MPa	26 28 34 38 43 46	26 28 34 38 43 46	26 28 34 38 43 46
Cylinder strength	$f_{cm,0}$ MPa	21 23 28 31 35 38	21 23 28 31 35 38	21 23 28 31 35 38
Outer diameter	mm	860 860 860 860 860	920 920 920 920 920	960 960 960 960 960
Bar diameter	mm	25 25 25 25 25	25 25 25 25 25	25 25 25 25 25
Pitch	mm	60 60 60 60 60	60 60 60 60 60	60 60 60 60 60
Number of pitches		17 17 17 17 17	19 19 19 19 19	20 20 20 20 20
Distance	E mm	90 90 90 90 90	100 100 100 100 100	110 110 110 110 110
Number of STIRRUPS		13 13 13 13 13	12 12 12 12 12	13 13 13 13 13
Bar diameter	mm	16 16 16 16 16	20 20 20 20 20	20 20 20 20 20
Spacing	mm	70 70 70 70 70	85 85 85 85 85	85 85 85 85 85
Distance	F mm	110 110 110 110 110	120 120 120 120 120	130 130 130 130 130
Minimum outer dimensions	A = B mm	940	1020	1060
Centre spacing	$a_c = b_c$ mm	960	1040	1080
Edge distance (+ c)	$a_e = b_e$ mm	470	510	530

1) If smaller, centre spacing and edge distances are required, refer to page 22 for guidance on space reduction. 2) All helix and stirrup reinforcement shall be ribbed reinforcing steel of grade 500 MPa. Grade 460 MPa steel may also be used if one additional stirrup of equivalent size is placed within the same length of the anchorage zone. The indicated stirrup spacings will have to be reduced accordingly. 3) Bar diameter of 14 mm can be replaced by 16 mm. 4) Prestressing strand with nominal diameter of 15.3 mm, cross sectional area of 140 mm² or with characteristic tensile strength below 1,860 MPa may also be used.



Annex – CONA CMF BT

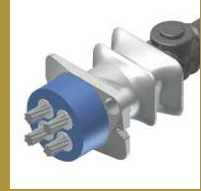
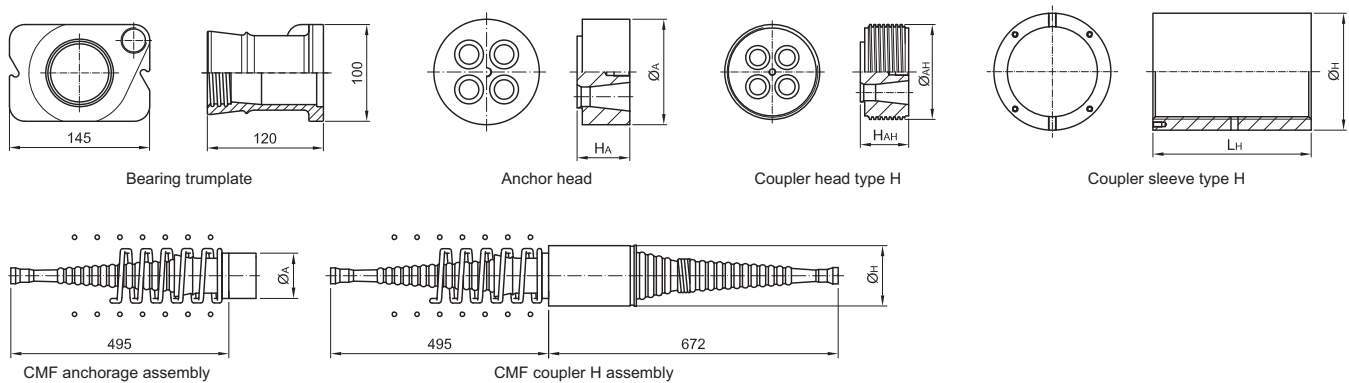

Table 30: CONA CMF component dimensions

Number of strands				02	03	04
Anchor head	Diameter	\varnothing_A	mm	90	100	100
	Height head A1-A4	H_A	mm	50	50	50
	Height head A5-A8		mm	65	65	65
Coupler head type H	Nominal diameter	\varnothing_{AH}	mm	90	100	100
	Height head H1	H_{AH}	mm	50	50	55
	Height head H2		mm	65	65	65
Coupler sleeve type H	Diameter	\varnothing_H	mm	114	121	130
	Length	L_H	mm	180	180	180



All dimensions in millimeters (mm)

CONA CMF anchorage and couple configurations

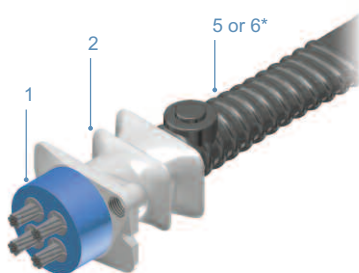

CONA CMF BT Anchorage

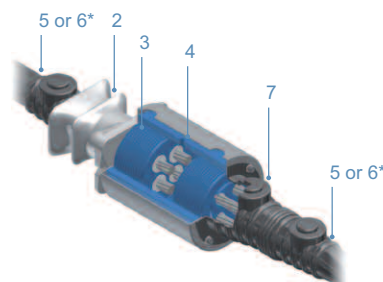

CONA CMF Coupler H

- 1 – Anchor head
- 2 – Bearing trumplate
- 3 – Coupler head type H
- 4 – Coupler sleeve type H
- 5 – Trumpet type A
- 6 – Trumpet type F
- 7 – Trumpet type FH
- * – Shown

CONA CMF minimum radius of curvature

The minimum radius of curvature of the tendon (R_{min}) is governed by the limiting radius of curvature for 05 and 06 strands. The minimum radius of curvature, eccentricity (e) and inner duct dimensions (d) for the BBRVT Plastic Duct and corrugated steel ducts are given in Tables 31 and 32 respectively.

Table 31: CONA CMF minimum radius of curvature, BBRVT Plastic Duct dimensions and eccentricity

		Corrugated Plastic Duct					
d _i major	d _i minor	R_{min} major			e		
		n05-100	n06-140	n06-150	n05-100	n06-140	n06-150
mm	mm	m			mm		
38	22	1.7	2.0	2.0	4.6	3.4	3.2
72	21				4.1	2.9	2.7
76	25				6.1	4.9	4.7

The indicated minimum radii of curvature values assume that the temperature of the concrete next to the plastic duct does not exceed 37 °C at the time of tendon stressing operations. For values at higher temperatures, please refer to the relevant European Technical Approval or contact your nearest BBR representative.

Annex – CONA CMF BT



Table 32: CONA CMF minimum radius of curvature, steel duct dimensions and eccentricity

Degree of filling	Round steel duct												Flat steel duct			
	$f \approx 0.25$				$f \approx 0.30$				$f \approx 0.35$				d_i major	d_i minor	R_{min} 140-200 kN/m	e
	d_i	R_{min}		e	d_i	R_{min}		e	d_i	R_{min}		e				
		140 kN/m	200 kN/m			140 kN/m	200 kN/m			140 kN/m	200 kN/m					
Number of Strands	mm	m		mm	m		mm	mm	m	m	mm	mm	mm	m	mm	
02 05	30	1.7	1.7	6	30	1.8	1.7	6	30	1.8	1.7	6	40	20	1.7	3.6
03 05	40	1.8	1.7	8	35	2.1	1.7	6	35	2.6	1.8	6	55	20		3.6
04 05	45	2.6	1.8	10	40	2.6	1.8	8	40	2.6	1.8	8	70	25		6.2
02 06	40	2.0	2.0	7	35	2.6	2.0	6	35	2.6	2.0	6	40	20	2.0	2.2
03 06	50	2.7	2.0	10	45	3.2	2.2	8	40	3.9	2.7	6	55	20		2.2
04 06	55	3.9	2.7	13	50	3.9	2.7	9	45	3.9	2.7	6	70	25		4.7

Table 33: CONA CMF anchor zone spacing and local reinforcement requirement for strands 05-100 1860

CONA CMF BT n05			02 05		03 05		04 05	
Cube strength	$f_{cm,0}$	MPa	21	25	21	25	21	25
Cylinder strength	$f_{cm,0}$	MPa	17	20	17	20	17	20
Outer diameter HELIX		mm	- / -	- / -	- / -	- / -	- / -	- / -
Bar diameter		mm	-	-	-	-	-	-
Pitch		mm	-	-	-	-	-	-
Number of pitches			-	-	-	-	-	-
Distance	E	mm	-	-	-	-	-	-
Number of STIRRUPS			4	4	4	4	7	7
Bar diameter		mm	8	8	10	10	10	10
Spacing		mm	50	50	50	50	50	50
Distance	F	mm	35	35	35	35	35	35
Minimum outer dimensions	A / B	mm	160 / 120	160 / 120	190 / 130	160 / 120	320 / 155	320 / 155
Centre spacing	a_c / b_c	mm	180 / 140	180 / 140	210 / 150	180 / 140	340 / 175	340 / 175
Edge distance (+ c)	a_e' / b_e'	mm	80 / 60	80 / 60	95 / 65	80 / 60	160 / 80	160 / 80

- 1) If smaller centre spacing and edge distances are required, refer to page 22 for guidance on space reduction.
- 2) All helix and stirrup reinforcement shall be ribbed reinforcing steel of grade 500 MPa. Grade 460 MPa steel may also be used if one additional stirrup of equivalent size is placed within the same length of the anchorage zone. The indicated stirrup spacings will have to be reduced accordingly.
- 3) Prestressing strand with nominal diameter of less than 12.9 mm and cross sectional area of less than 100 mm² or with characteristic tensile strength below 1,860 MPa may also be used.

Table 34: CONA CMF anchor zone spacing and local reinforcement requirement for strands 06-150 1860

CONA CMF BT n06			02 06		03 06		04 06	
Cube strength	$f_{cm,0}$	MPa	21	25	21	25	21	25
Cylinder strength	$f_{cm,0}$	MPa	17	20	17	20	17	20
Outer diameter HELIX		mm	- / -	- / -	- / -	240 / 110	- / -	240 / 130
Bar diameter		mm	-	-	-	10	-	10
Pitch		mm	-	-	-	45	-	45
Number of pitches			-	-	-	6	-	7
Distance	E	mm	-	-	-	15	-	15
Number of STIRRUPS			4	4	-	6	-	7
Bar diameter		mm	10	10	-	10	-	10
Spacing		mm	50	50	-	50	-	50
Distance	F	mm	35	35	-	35	-	35
Minimum outer dimensions	A / B	mm	190 / 130	160 / 120	- / -	290 / 155	- / -	290 / 180
Centre spacing	a_c / b_c	mm	210 / 150	180 / 140	- / -	310 / 175	- / -	310 / 200
Edge distance (+ c)	a_e' / b_e'	mm	95 / 65	80 / 60	- / -	145 / 80	- / -	145 / 90

- 1) If smaller centre spacing and edge distances are required, refer to page 22 for guidance on space reduction.
- 2) All helix and stirrup reinforcement shall be ribbed reinforcing steel of grade 500 MPa. Grade 460 MPa steel may also be used if one additional stirrup of equivalent size is placed within the same length of the anchorage zone. The indicated stirrup spacings will have to be reduced accordingly.
- 3) Prestressing strand with nominal diameter of 15.3 mm, cross sectional area of 140 mm² or with characteristic tensile strength below 1,860 MPa may also be used.

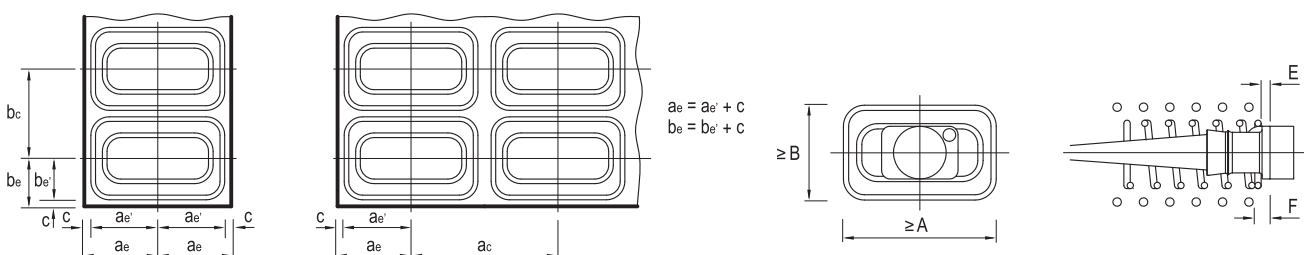

Annex – CONA CMM (Single)



CONA CMM (Single) component dimensions

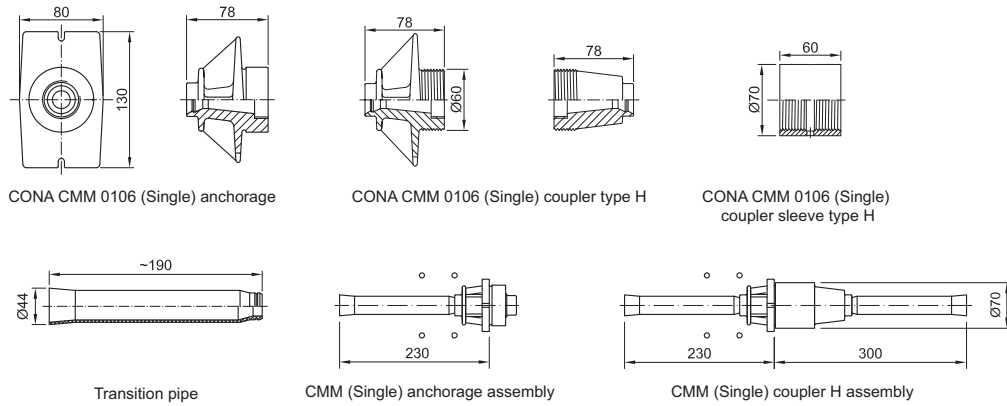

All dimensions in millimeters (mm)

CONA CMM (Single) anchorage and couple configurations

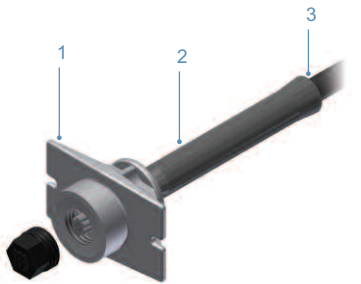

CONA CMM (Single) Anchorage

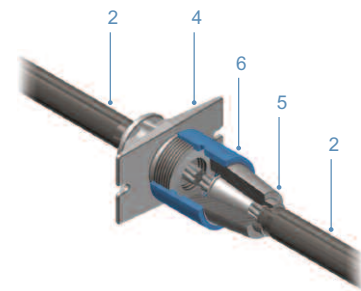

CONA CMM (Single) Coupler H

- 1 – Load transfer element
- 2 – Transition pipe
- 3 – Monostrand
- 4 – Coupler head type H, constr. phase 1
- 5 – Coupler head type H, constr. phase 2
- 6 – Coupler sleeve type H

CONA CMM (Single) minimum radius of curvature

The minimum radius of curvature of a CONA CMM (Single) (R_{min}) is 2.5 m. Smaller radii are possible for special applications.

Table 35: CONA CMM (Single) anchor zone spacing and local reinforcement requirement for strands 06-150 1860 or 06C-165 1820

CONA CMM (Single)			01 06
Cube strength	$f_{cm,0}$	MPa	24
Cylinder strength	$f_{cm,0}$	MPa	20
Outer diameter HELIX		mm	-
Bar diameter		mm	-
Pitch		mm	-
Number of pitches			-
Distance	E	mm	-
Number of STIRRUPS			2
Bar diameter		mm	8
Spacing		mm	50
Distance	F	mm	55
Minimum outer dimensions	A / B	mm	140 / 100
Centre spacing	a_c / b_c	mm	180 / 140
Edge distance (+ c)	a_e' / b_e'	mm	70 / 50

- 1) If smaller centre spacing and edge distances are required, refer to page 22 for guidance on space reduction.
- 2) All helix and stirrup reinforcement shall be ribbed reinforcing steel of grade 500 MPa. Grade 460 MPa steel may also be used if one additional stirrup of equivalent size is placed within the same length of the anchorage zone. The indicated stirrup spacings will have to be reduced accordingly.
- 3) Prestressing strand with nominal diameter of 15.3 mm, cross sectional area of 140 mm² or with characteristic tensile strength below 1,860 MPa may also be used.

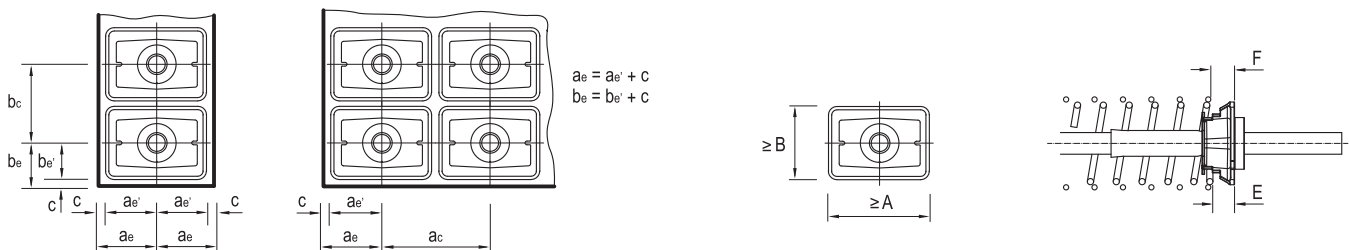

Annex – CONA CMM (Two/Four)



CONA CMM (Two/Four) component dimensions

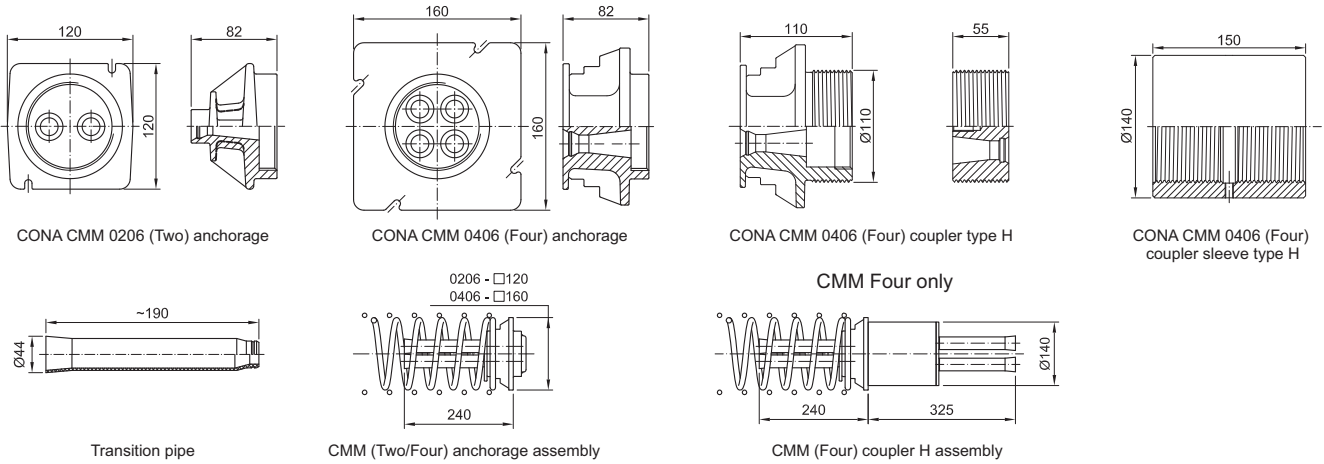

All dimensions in millimeters (mm)

CONA CMM (Two/Four) anchorage and couple configurations

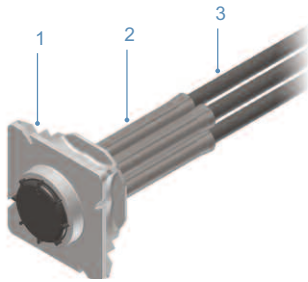

CONA CMM (Two/Four) Anchorage

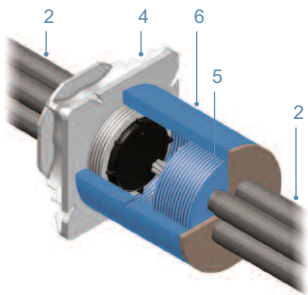

CONA CMM (Four) Coupler H

- 1 – Load transfer element
- 2 – Transition pipe
- 3 – Monostrand
- 4 – Coupler head type H, constr. phase 1
- 5 – Coupler head type H, constr. phase 2
- 6 – Coupler sleeve type H

CONA CMM (Two/Four) minimum radius of curvature

In Table 36, the minimum radius of curvature of the tendon (R_{min}) is shown against the type of tendon. Smaller radii are possible for special applications.

Table 36: CONA CMM (Two/Four) minimum radius of curvature

Number of strands	R_{min}
n	m
02 06	3.5
04 06	3.5

Table 37: CONA CMM (Two/Four) anchor zone spacing and local reinforcement requirement for strands 06-150 1860 or 06C-165 1820

CONA CMM (Two/Four)			02 06	04 06
Cube strength	$f_{cm,0}$	MPa	24	24
Cylinder strength	$f_{cm,0}$	MPa	20	20
Outer diameter HELIX		mm	100	160
Bar diameter		mm	10	12
Pitch		mm	40	50
Number of pitches			4	5
Distance	E	mm	50	45
Number of STIRRUPS			4	6
Bar diameter		mm	10	10
Spacing		mm	50	55
Distance	F	mm	25	53
Minimum outer dimensions	A / B	mm	180 / 130	260 / 180
Centre spacing	a_c / b_c	mm	200 / 150	300 / 220
Edge distance (+ c)	a_e' / b_e'	mm	90 / 65	130 / 90

- 1) If smaller centre spacing and edge distances are required, refer to page 22 for guidance on space reduction.
- 2) All helix and stirrup reinforcement shall be ribbed reinforcing steel of grade 500 MPa. Grade 460 MPa steel may also be used if one additional stirrup of equivalent size is placed within the same length of the anchorage zone. The indicated stirrup spacings will have to be reduced accordingly.
- 3) Prestressing strand with nominal diameter of 15.3 mm, cross sectional area of 140 mm² or with characteristic tensile strength below 1,860 MPa may also be used.

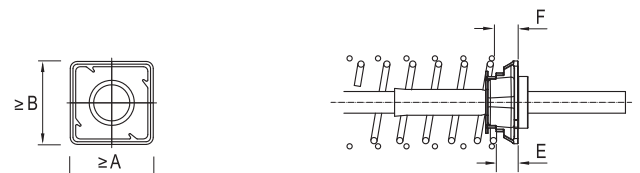
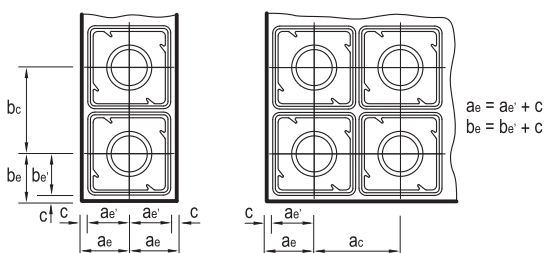

Annex – CONA CMB SP

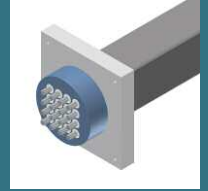
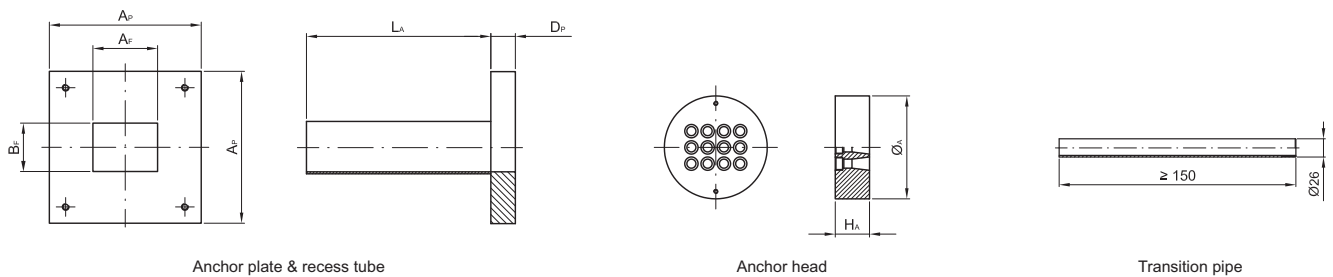

Table 38: CONA CMB component dimensions

Number of strands			01 x 01 06	01 x 02 06	02 x 02 06	03 x 02 06	01 x 04 06	02 x 04 06	03 x 04 06	04 x 04 06	
Anchor head	Diameter	\varnothing_A	mm	60	100	110	160	180	180	200	210
	Height	H_A	mm	60	60	60	60	60	60	60	70
Anchor plate & recess tube	Side length	$A_P \times A_P$	mm	80	120	160	200	230	230	270	310
	Thickness	D_P	mm	10	15	20	25	30	30	40	50
	Side length	$A_F \times B_F$	mm	34 x 34	64 x 34	64 x 64	64 x 104	134 x 34	134 x 64	134 x 104	134 x 134
	Min. length	L_A	mm	300	300	300	300	300	300	300	300



All dimensions in millimeters (mm)

CONA CMB anchorage and couple configurations

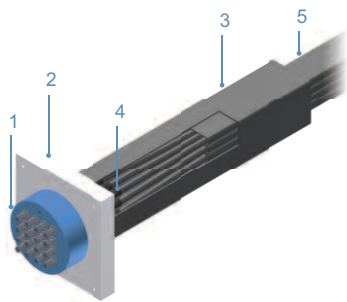

CONA CMB SP Anchorage

- 1 – Anchor head
- 2 – Anchor plate
- 3 – Recess tube
- 4 – Transition pipe
- 5 – Strand band bundles

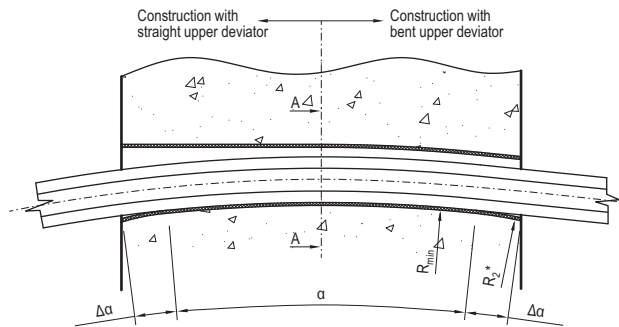

Critical Dimensions at Deviator/Saddle
* = $R_2 < R_{min}$

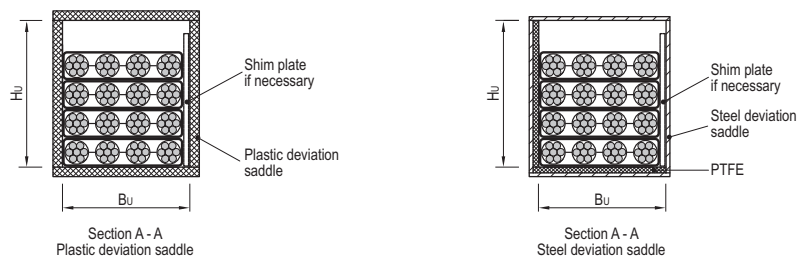

CONA CMB minimum radius of curvature

In Table 39, the minimum radius of curvature of the tendon (R_{min}) is given corresponding to a prestressing force of the tendon of $0.85 F_{p0,1}$, a inner sheathing thickness of 1.75 mm and a radius of curvature around the second, perpendicular axis $R_H \geq 10$ m. Other radii are applicable for special applications or other types of strands subject to consultation and approval with the ETA holder:

Table 39: CONA CMB minimum radius of curvature and saddle dimensions

Band configuration	Bands	Number of strands n 06	R_{min}			Min. Width B_u^*	Min. Height H_u^*
			n06-140	n06-150	n06C-165		
01 x 01 06	1	01 06	2.0	2.0	2.0	35	40
01 x 02 06	1	02 06	2.0	2.0	2.0	70	40
02 x 02 06	2	04 06	2.8	3.0	2.2	70	70
03 x 02 06	3	06 06	4.2	4.5	3.4	70	100
01 x 04 06	1	04 06	2.0	2.0	2.0	110	40
02 x 04 06	2	08 06	2.8	3.0	2.2	110	70
03 x 04 06	3	12 06	4.2	4.5	3.4	110	100
04 x 04 06	4	16 06	5.6	6.0	4.5	110	130

Annex – CONA CMB SP

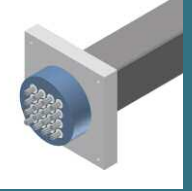
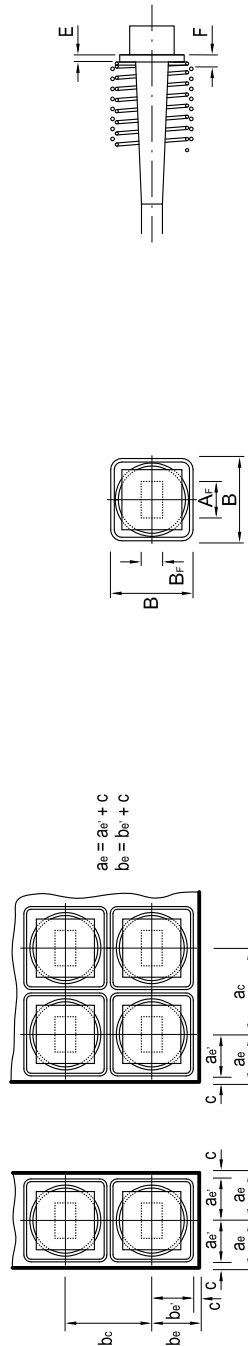

Table 40: CONA CMB SP anchor zone spacing and local reinforcement requirement for strands 06- 150 1860 or 06C- 165 1820

CONA CMB SP n06		01 06	02.06	04.06 (2 x 2)	06.06 (3 x 2)	04.06 (1 x 4)	08.06 (2 x 4)	12.06 (3 x 4)	16.06 (4 x 4)
Cube strength	f_{cm0} MPa	35	35	35	35	35	35	35	35
Cylinder strength	f_{cm0} MPa	29	29	29	29	29	29	29	29
Outer diameter HELIX	mm	-	-	180	210	210	260	320	380
Bar diameter	mm	-	-	10	12	12	14	14	14
Pitch	mm	-	-	40	50	50	50	50	50
Number of pitches		-	-	5	5	6	6	6.5	7
Distance	E mm	-	-	25	30	30	30	40	50
Number of STIRRUPS		3	5	4	4	4	4	6	6
Bar diameter	mm	12	12	10	12	12	12	12	12
Spacing	mm	40	40	55	70	70	70	65	70
Distance	F mm	30	35	45	50	50	50	60	70
Minimum outer dimensions	A = B mm	90	140	200	240	230	275	340	400
Centre spacing	$a_c = b_c$ mm	115	160	220	260	250	290	370	420
Edge distance (+ c)	$a_e' = b_e'$ mm	50	70	100	120	115	135	180	200

1) If smaller centre spacing and edge distances are required, refer to page 22 for guidance on space reduction. 2) All helix and stirrup reinforcement shall be ribbed reinforcing steel of grade 500 MPa. Grade 460 MPa steel may also be used if one additional stirrup of equivalent size is placed within the same length of the anchorage zone. The indicated stirrup spacings will have to be reduced accordingly. 3) Bar diameter of 14 mm can be replaced by 16 mm. 4) Prestressing strand with nominal diameter of 15,3 mm, cross sectional area of 140 mm² or with characteristic tensile strength below 1,860 MPa may also be used.



Annex – Notations, units and reference documents

List of Notations		
A	[mm]	minimum horizontal outer dimensions of additional reinforcement
A_{gt}	[%]	minimum elongation at maximum force of prestressing steel
A_c	[mm ²]	minimum concrete area in the local zone
A_p	[mm ²]	nominal cross-sectional area of prestressing steel
a_c	[mm]	minimum horizontal centre spacing
a_c	[mm]	reduced minimum horizontal centre spacing (15% rule)
a_e	[mm]	minimum horizontal edge distance
a_e'	[mm]	minimum horizontal edge distance without cover
B	[mm]	minimum vertical outer dimensions of additional reinforcement
b_c	[mm]	minimum vertical centre spacing
b_c	[mm]	reduced minimum vertical centre spacing (15% rule)
b_e	[mm]	minimum vertical edge distance
b_e'	[mm]	minimum vertical edge distance without cover
c	[mm]	concrete cover
d	[mm]	nominal strand diameter
d_i	[mm]	inner diameter of duct, major and minor axis dimensions may also be indicated for flat ducts
d_o	[mm]	outer diameter of duct, major and minor axis dimensions may also be indicated for flat ducts
E	[mm]	distance of helix lowercase from anchor plate
E_p	[MPa]	modulus of elasticity of prestressing steel
e	[mm]	eccentricity of the tendon
F	[mm]	distance of additional reinforcement from the anchor plate
f	[-]	degree of filling
$f_{ck,cube}$	[MPa]	characteristic concrete compressive strength (cubic specimen)
$f_{ck,cylinder}$	[MPa]	characteristic concrete compressive strength (cylindrical specimen)
$f_{cm,cube}$	[MPa]	mean concrete compressive strength (cubic specimen)
$f_{cm,cylinder}$	[MPa]	mean concrete compressive strength (cylindrical specimen)
$f_{cm,0}$	[MPa]	mean concrete compressive strength at the time of full prestressing
f_{pk}	[MPa]	maximum characteristic tensile strength of prestressing steel
F_{pk}	[kN]	characteristic value of maximum force of tendon
$f_{p0,1}$	[kN]	characteristic value of 0.1% proof stress of the tendon
$F_{p0,1}$	[kN]	characteristic value of 0.1% proof force of the tendon
$F_{pm,0}$	[kN]	prestressing force of the tendon
f_{pp}	[MPa]	limit of proportionality of prestressing steel
F_o	[kN]	prestressing force at $x = 0$ m
f_R	[-]	converting factor from 1,860 MPa strand to 1,770 MPa strand
F_x	[kN]	prestressing force at a distance x along the tendon
G.C.D.	[mm]	center of gravity of the duct
G.C.S.	[mm]	center of gravity of the strands
k	[rad/m]	wobble coefficient
k_{as}	[m ⁻¹]	wobble equivalent coefficient (American Standards)
K_f	[-]	stable factor
L_{min}	[mm]	minimum straight length
M	[kg/m]	mass per meter of prestressing steel
n	[-]	number of strands in a tendon
OD_{Helix}	[mm]	outer diameter of helix
$p_{R,max}$	[kN/m]	maximum contact pressure between prestressing strands, duct and concrete
R_b	[m]	minimum radius of curvature to protect the strand from excessive bending stresses
R_{min}	[m]	minimum radius of curvature
t_{min}	[mm]	minimum wall thickness of duct
x	[m]	distance along the tendon from the point where the prestressing force is equal to F_0
a	[rad]	sum of angular displacements over distance x
μ	[rad ⁻¹]	friction coefficient

Annex – Notations, units and reference documents

List of Units	
kg	kilogram (1 kg = 1,000 gram)
in.	inch (1 in. = 25.4 mm)
m	meter
mm	millimeter
mm ²	square millimeter
Pa	Pascal (1 N/m ²)
MPa	megapascal (1 MPa = 1 N/mm ²)
N	Newton [kg · m · s ⁻²] (1 kg ≈ 9.81 N)
kN	kilonewton (1 kN = 1,000 N)
rad	radiant (2π = 360 deg)
s	second

Guidelines	
ETAG 013 (06.2002)	Guideline for European Technical Approval of Post-Tensioning Kits for Prestressing of Structures
fib Bulletin 7 (01.2000)	Corrugated plastic ducts for internal bonded post-tensioning

Standards	
EN 206-1+A1+A2 (06.2005)	Concrete – Part 1: Specification, performance, production and conformity
EN 445 (10.2007)	Grout for prestressing tendons – Test methods
EN 446 (10.2007)	Grout for prestressing tendons – Grouting procedures
EN 447 (10.2007)	Grout for prestressing tendons – Specification for common grout
EN 523 (08.2003)	Steel strip sheaths for prestressing tendons – Terminology, requirements, quality control
EN 1561 (06.1997)	Founding – Grey cast irons
EN 1563+A1+A2 (07.2005)	Founding – Spheroidal graphite cast irons
EN 1992-1-1+AC (01.2008)	Eurocode 2: Design of concrete structures – Part 1-1: General rules and rules for buildings
EN 10025-2+AC (06.2005)	Hot rolled products of structural steels – Part 2: Technical delivery conditions for non-alloy structural steels
EN 10083-1 (08.2006)	Quenched and tempered steels – Part 1: Technical delivery conditions for special steels
EN 10083-2 (08.2006)	Quenched and tempered steels – Part 2: Technical delivery conditions for unalloyed quality steels
EN 10084 (04.2008)	Case hardening steels – Technical delivery conditions
EN 10204 (10.2004)	Metallic products – Types of inspection documents
EN 10210-1 (04.2006)	Hot finished structural hollow sections of non-alloy and fine grain structural steels – Part 1: technical delivery requirements
EN 10216-1+A1 (03.2004)	Seamless steel tubes for pressure purposes – Technical delivery conditions – Part 1: Non-alloy steel tubes with specified room temperature properties
EN 10217-1+A1 (01.2005)	Welded steel tubes for pressure purposes – Technical delivery conditions – Part 1: Non-alloy steel tubes with specified room temperature properties
EN 10219-1 (04.2006)	Cold formed welded structural hollow sections of non-alloy and fine grain steels – Part 5 1: Technical delivery conditions
EN 10255 (04.2007)	Non-alloy steel tubes suitable for welding and threading – Technical delivery conditions
EN 10270-1 (04.2001)	Steel wire for mechanical springs – Part 1: Patented cold drawn unalloyed steel wire
EN 10277-2 (03.2008)	Bright steel products – Technical delivery conditions – Part 2: Steels for general engineering purposes
EN 10305-5 (01.2010)	Steel tubes for precision applications – Technical delivery conditions – Part 5: Welded and cold sized square and rectangular tubes
EN 12201 (03.2003)	Plastics piping systems for water supply – Polyethylene (PE)
EN ISO 1872-1 (05.1999)	Plastics – Polyethylene (PE) moulding and extrusion materials – Part 1: Designation system and basis for specifications (ISO 2872-1:1993)
EN ISO 1874-1 (09.2000)	Plastics – Polyamide (PA) moulding and extrusion materials – Part 1: Designation (ISO 1874-1:1992)
prEN 10138-3 (08.2009)	Prestressing steels – Part 3: Strands
CWA 14646 (01.2003)	Requirements for the installation of post-tensioning kits for prestressing of structures and qualification of the specialist company and its personnel
DIN 1045-1	German standards – design of reinforced and prestressed concrete structures
SIA 262	Swiss standards – concrete structures
AS/NZS 4672.1:2007	Standards Australia – steel prestressing Materials – part 1: General requirements
ASTM A416	Standard Specification for Steel Strand, Uncoated Seven Wire for Prestressed Concrete

Annex – Additional post-tensioning systems

BBR VT CONA CMC

Cast-in and inaccessible bond anchorages

Load transfer is achieved by a local deformation of the strand and bond to the concrete. Local BBR Network Members

offer a variety of solutions, such as onion or loop anchorages which fully comply with regulations applicable at the place of use.

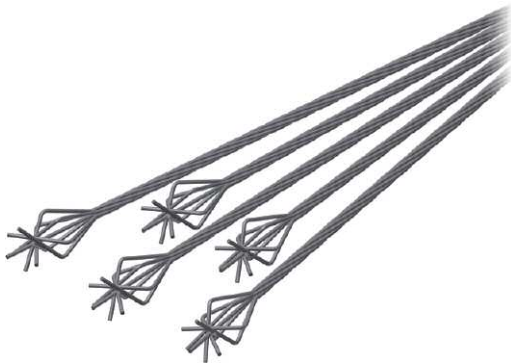

Flat onion anchorage
CONA CMC

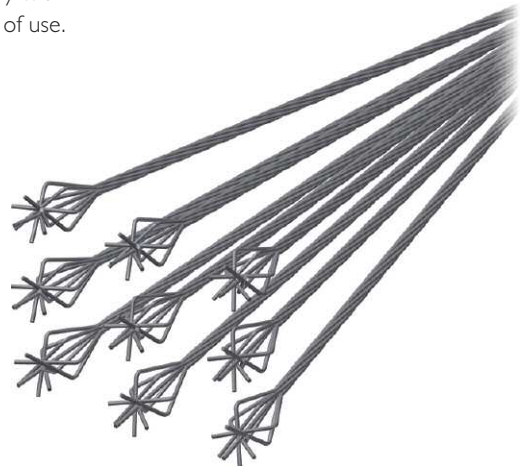

Bundle onion anchorage
CONA CMC

BBR VT Classic Systems

Additional BBR VT post-tensioning systems

Since 1944, BBR has developed and pioneered post-tensioning introducing many systems over the past six decades. In specific markets, some of these earlier systems might still be used to complement

special applications – or, in some cases, they are still the locally approved systems. The BBR CONA, CONA compact, CONA multi, CONA Single and CONA flat post-tensioning systems have been

used for decades and in 2005, the BBR post-tensioning range was further complemented with the post-tensioning systems previously used by Vorspann-Technik (Austria / Germany).



BBR CONA multi



BBR CONA compact

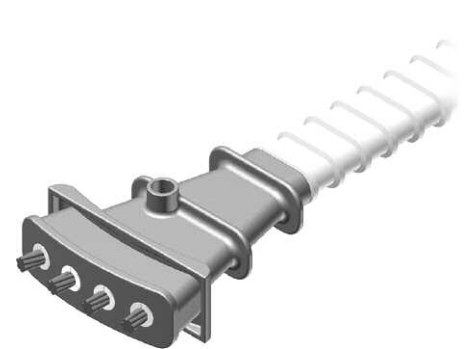

BBR CONA flat

And finally

Having reached this page, you can certainly be in no doubt as to our commitment to the finest technology and our enthusiasm for delivering our projects.

Our six decades of experience has resulted in BBR technology being applied to thousands of structures around the world and, in the process, we have continued to refine and enhance our range. The result is that we can supply simply the best technology available – the BBR VT CONA CMX system.

Technology does not however develop by itself – all through the years, we have been fortunate enough to have attracted some of the best engineers in the business. It is their dedication which has maintained the BBR reputation – and continues to do so today.

Our well-established worldwide network is supported in the development of major structures by our Special Projects Team who will help to specify and procure the systems required. So, local knowledge synchronises with international know-how to realise projects – some large, some smaller, but always technically excellent and fit-for-purpose!



BBR VT International Ltd
Bahnstrasse 23
8603 Schwerzenbach (ZH)
Switzerland

Tel +41 44 806 80 60
Fax +41 44 806 80 50

www.bbrnetwork.com
info@bbrnetwork.com

BBR VT International Ltd
Technical Headquarters and Business Development Centre
Switzerland



A Global Network of Experts
www.bbrnetwork.com