



**ANNIVERSARY**

1944-2014



## **BBR** A Global Network of Experts

[www.bbrnetwork.com](http://www.bbrnetwork.com)

The BBR Network is recognized as the leading group of specialized engineering contractors in the field of post-tensioning, stay cable and related construction engineering. The innovation and technical excellence, brought together in 1944 by its three Swiss founders – Antonio Brandestini, Max Birkenmaier and Mirko Robin Ros – continues, 70 years later, in that same ethos and enterprising style.

From its Technical Headquarters and Business Development Centre in Switzerland, the BBR Network reaches out around the globe and has at its disposal some of the most talented engineers and technicians, as well as the very latest internationally approved technology.

### **THE GLOBAL BBR NETWORK**

Within the Global BBR Network, established traditions and strong local roots are combined with the latest thinking and leading edge technology. BBR grants each local BBR Network Member access to the latest technical knowledge and resources – and facilitates the exchange of information on a broad scale and within international partnering alliances. Such global alliances and co-operations create local competitive advantages in dealing with, for example, efficient tendering, availability of specialists and specialized equipment or transfer of technical know-how.

### **ACTIVITIES OF THE NETWORK**

All BBR Network Members are well-respected within their local business communities and have built strong connections in their respective regions. They are all structured differently to suit the local market and offer a variety of construction services, in addition to the traditional core business of post-tensioning.

### **BBR TECHNOLOGIES & BRANDS**

BBR technologies have been applied to a vast array of different structures – such as bridges, buildings, cryogenic LNG tanks, dams, marine structures, nuclear power stations, retaining walls, tanks, silos, towers, tunnels, wastewater treatment plants, water reservoirs and wind farms. The BBR brands and trademarks – CONA®, BBRV®, HiAm®, HiEx, DINA®, SWIF®, BBR E-Trace and CONNÆCT® – are recognized worldwide.

The BBR Network has a track record of excellence and innovative approaches – with thousands of structures built using BBR technologies. While BBR's history goes back over 70 years, the BBR Network is focused on constructing the future – with professionalism, innovation and the very latest technology.

BBR VT International Ltd is the Technical Headquarters and Business Development Centre of the BBR Network located in Switzerland. The shareholders of BBR VT International Ltd are: BBR Holding Ltd (Switzerland), a subsidiary of the Tectus Group (Switzerland); KB Spennteknikk AS (Norway), BBR Polska z o.o. (Poland) and KB Vorspann-Technik GmbH (Germany) – all three are members of KB Group (Norway); BBR Pretensados y Tecnicas Especiales PTE, S.L. (Spain), a member of the FCC Group (Spain).





**ANNIVERSARY**

1944-2014

# 70 YEARS OF SUCCESS

It gives us great pleasure to present to you this BBR 70th Anniversary brochure in celebration of our milestone achievement.

Inside, you will find an overview of BBR's past, present and future. We take you on a journey through the BBR Network's current technology and service offering, the structure and management of the franchise and feature articles by key personalities within the organisation. The voyage continues with a review of BBR history, including some of our earliest projects and innovations along the way. You will read about how BBR led the way in stay cable and post-tensioning technology right from the start. Also included is a feature on landmark projects which we consider to be BBR's seven 'Wonders of the World'. Last but not least, after looking backwards, we focus on what the future could hold for us all.

This brochure is not only dedicated to celebrating BBR's 70th Anniversary, but also to the very many professionals, from around the BBR Network and from other organisations with whom we work, who have shared and enriched our journey. We look forward to working with you during the next 70 years – and, meanwhile, hope you enjoy reading the following pages!

**Board of Directors**

**BBR VT International Ltd**

Marcel Poser, José Manuel Illescas, Bruno Valsangiacomo,  
Peter Ekberg, Fernando Tejada, Svein Finstad,  
Tore Thorstensen, Erling Strøm

BBR's three founders – Antonio Brandestini, Mirko Robin Roš and Max Birkenmaier.



## FOREWORD

by Dr. Antonio Caballero, CEO, BBR VT International Ltd

# CREATING 'LIGHT BULB' MOMENTS TOGETHER

Seventy years is a long time and many readers were not even born when BBR was founded in 1944. Dr. Antonio Caballero, CEO of BBR VT International Ltd, shares a few thoughts about the special blend of ingredients which created and will sustain BBR's success long into the future.

Since BBR came into being, the world has seen a major transformation – in terms of technological development, social and environmental awareness and economic outlook. We now live in an age where communication and information have never been more readily accessible and where caring for our planet and its communities have become a priority – yet still the BBR

brand and all that it represents remains at the forefront. This did not happen by some happy accident.

The past has shown us that what was valid yesterday might not be true today or tomorrow. We need to be flexible, open minded and constantly on the look-out, so we can predict the next change and be ready from the day before zero.

### Shared vision

The consistent success and relevance of the BBR offering is partly a result of the vision of our founding fathers and the valuable legacy they created for us, but also attributable to the people who – together – have shared and extended this vision down the years. In fact, some projects have only been possible because BBR Network Members had the ambition and inspiration – combined, of course, with leading edge engineering expertise – to execute them. Striving for still greater excellence and embracing change is all part of the continuous process of evolution. BBR's 'next generation' is already taking ownership of the challenges and driving our technology and services towards new horizons. There are people within and around the BBR Network whose insight and expertise is being applied to developing new technology and services for us all to take to market.

### Passion & innovation

Where enthusiasm, passion and expertise blend, there will always be innovative solutions. It's what drove our founders and, if we're honest, drives most of us too. The challenge of creating something new that solves a problem is irresistible. Harnessing that spark which ignites creativity is crucial. Without giving too much away, I can tell you that we're currently working on the development of new PT systems which will enable the BBR Network to enter into a new age with a holistic view and approach – where compliance will combine with technical requirements, where clear commercial added value will feature in the entire construction process and where there will be still further special consideration for the environment and sustainability. In a separate innovation, we're also working on the development of a new construction system for building structures which has, as its main focus, the provision of more flexible space for owners, users and architects. Beyond this, we're looking at opening new lines of business which will widen the spectrum of works that our Members can tackle. There's nothing more exciting than seeing BBR Network Members at conferences, training sessions and workshops having one of those 'light bulb' moments. This is something I'd like to build on – and encourage even more such dialogues at our gatherings.



### Open minds

We have always planned for success, yet remained sufficiently flexible and open minded to take on board new concepts and information. One of the key things here is listening to what people – our customers – need and how they feel about the way we provide our service to them. Feedback is the lifeblood of our business and we greatly value the input from the BBR Network, they are our eyes and ears in the field. Our constellation of Network Members is indeed an open-minded setup. Conversely to other set-ups in which a company opens offices in countries other than its homeland, our Members are recognized and skilled local companies who appreciate the benefit of belonging to a globally known brand. This business format ensures the international technology exchange, business scalability and shared technical and business know-how while the local flavor – which is so appreciated by customers around the world – is delivered by locally based specialists. The BBR Network is a great team – together we create the infrastructure that makes our daily lives possible and our technology and approach allows us to do it in a way which is kinder on the environment. At the end of the day, we are merely custodians of all that surrounds us, but wouldn't it be amazing if we could – together – develop a legacy as fine as that of our founding fathers? I look forward to working with you all towards that common goal. With best regards,

“BBR's 'next generation' is already taking ownership of the challenges and driving our technology and services towards new horizons.”

*Antonio Caballero*



# CONTENTS

08

## THE FAMILY FIRM

Bruno Valsangiacomo talks about how he became involved with BBR, its people and the challenges overcome

12

## ALWAYS ONE STEP AHEAD

BBR post-tensioning and stay cable technology for the modern era

14

## STATE-OF-THE-ART POST-TENSIONING WITH BBR VT CONA CMX

The BBR Network's complete range of post-tensioning systems, covering all possible structural and civil engineering applications, are showcased here

16

## RELIABLE AND FLEXIBLE BBR STAY CABLES

Overview of state-of-the-art Swiss BBR stay cable technology, applied to 420 projects worldwide

18

## ENGINEERING EXCELLENCE IN BRIDGE CONSTRUCTION & HEAVY LIFTING

Specialist heavy construction techniques used by the BBR Network

21

## GIVING NEW LIFE TO STRUCTURES

Methods and technology regularly used by BBR Network Members to revitalise damaged or ageing structures

22

## 21ST CENTURY RENAISSANCE

Thomas Richli reveals the background to the creation of the BBR Network – the world's largest franchise of its kind

25

## IN THE BOARDROOM

The structure and the people who run BBR VT International Ltd

28

## OUT AND ABOUT

BBR people and special moments captured in photographs

32

## WONDERS OF THE BBR WORLD

Seven iconic projects of BBR's world

36

## NURTURING INNOVATION

Where the journey began – people, places and events behind the development of BBR

38

## JOURNEY THROUGH TIME

Charting the milestones in BBR's 70 year history

40

## CENTERPIECES AND MASTERPIECES

Exploring BBR innovation in stay cable bridges

48

## BRIDGING PAST, PRESENT AND FUTURE

BBR technology and expertise at the forefront of bridge construction

52

## ARCHITECTURAL FREEDOM

Buildings made possible by using BBR technology

54

## CREATING TECHNOLOGY AND TECHNIQUES

Some of the world's most challenging projects – realised with BBR technology and expertise

58

## VIRTUAL GOES REALITY

Marcel Poser takes a look at how the future could unfold



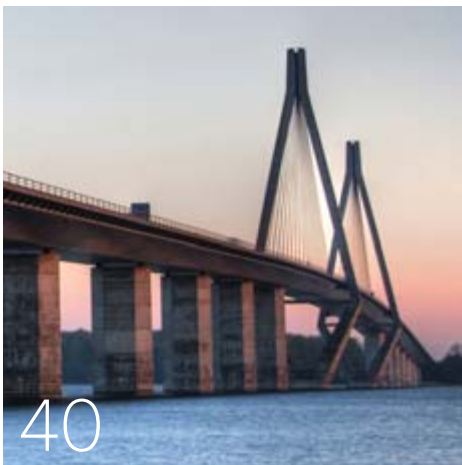

## EDITORIAL, SOURCES AND REFERENCES

### EDITORIAL OFFICE

BBR VT International Ltd  
 Technical Headquarters and Business Development Centre  
 Switzerland  
[www.bbrnetwork.com](http://www.bbrnetwork.com)  
[info@bbrnetwork.com](mailto:info@bbrnetwork.com)

### EDITOR

Jane Sandy

### DESIGNER

Jenny Chillingworth

### CONTRIBUTORS

Cornelia Bodmer-Roš, Peter Bruder, Antonio Caballero, Jürg Däniker, Robert Freedman, Hans Rudolf Müller, Behzad Manshadi, Valentina Mihajlovic, Thomas Richli, Bruno Valsangiacomo, Wilhelm Zellner

### PUBLISHER

BBR VT International Ltd

Every effort is made to ensure that the content of this edition is accurate but the publisher accepts no responsibility for effects arising there from.  
 p-ISSN 1664-6606  
 e-ISSN 1664-6614  
 © BBR VT International Ltd 2014

### SOURCES AND REFERENCES

BBR archive

Stahlton archive

BBR Innovative Engineering Review, 2004

BBRV Anchorages Used in Various Types of Soil by Hans Rudolf Müller  
 Dipl.-Ing. ETH, English translation of a lecture given at the Swiss Society for Soil Mechanics and Foundation Technology Conference in Zurich, 24th May 1965  
 Der Autobahn-Talübergang Brenntenmais (EW18) by Dipl.-Ing. Wilhelm Zellner, published in VERKEHRS-wirtschaft Wien – Heft 3-4/62

Cable-Stayed Bridges: 40 Years of Experience Worldwide by Dipl.-Ing. Holger Svensson, published 2012, John Wiley & Sons Limited, ISBN 3433029776  
 Schillersteg, Stuttgart, [www.bundesgartenschau.de](http://www.bundesgartenschau.de) (accessed January 2014)

The Use of the BBRV System for Producing Prestressed Concrete Railroad Ties (Railway Sleepers) by Dipl.-Ing. George Zenobi

Prestressed Concrete in Sub-Aqueous Tunnel Construction by Per Hall, Armand Couture and Graham Earle, Journal of the Prestressed Concrete Institute, Vol 10, No 4, August 1965

Zwei bemerkenswerte Bauwerke in Spannbeton in den USA und in Canada by M R Roš Dipl. Bau-Ing. Zürich, published in Schweizerische Bauzeitung, Year 83, Volume 37, 16 September 1965

Installing Prestressing Tendons in Arduous Conditions by G.R.Sides and H.R.Müller Dipl.-Ing. ETH, 11th Congress, International Association for Bridge and Structural Engineering, 1980

Zur Palme Hochhaus, [www.de.wikipedia.org](http://www.de.wikipedia.org) (accessed January 2014)

Rivergate Convention Center, New Orleans, [www.tulane.edu](http://www.tulane.edu) (accessed January 2014)

Plaza de Toros, Cali, Columbia, [www.ihf.info](http://www.ihf.info) (accessed January 2014)

This paper is manufactured with 15% recycled fibre, FSC certified.

All pulps used are Elemental Chlorine Free (EFC) and the manufacturing mill is accredited with the ISO14001 standard for environmental management. Vegetable based inks have been used and 85% of all waste associated with this product has been recycled.

## INTRODUCTION

Interview with Bruno Valsangiacomo

# THE FAMILY FIRM

For the first time, in a rare interview, for this 70th Anniversary commemorative brochure, Bruno Valsangiacomo, BBR VT International Board Member and Executive Chairman of the Tectus Group ([www.tectusgroup.com](http://www.tectusgroup.com)), a shareholder of BBR VT, goes on the record about how he first became involved with BBR, his recollections of the past and his aspirations for the business going forward.





**How did your involvement with BBR begin?**

By getting married, in 1981, to Claudia Brandestini – the daughter of one of the three founders of BBR – I got to know the companies, including BBR, initially in a rather passive role. At that time, I was fully engaged with making a career in the banking industry. It was ten years later when what I guess you might call ‘the defining moment’ came. In 1991, I started my own firm and also co-founded the ITI Group, which today owns Poland’s largest television business, an operation I lead today as its Executive Chairman. At the same time that I started to build up the Polish business, my father in law, Antonio Brandestini, asked me to look after the family’s investments in Stahlton, Bureau BBR and Proceq.

**What was Bureau BRR at that time?**

A brand and post-tensioning system that was known worldwide. However, age had crept up on it – you might say it was sitting in a rocking chair on the porch. The business was trying to keep itself above water with some continuous license income – which was more a brand usage payment – and occasional jobs. But, most importantly, the features of a sleeping beauty were still visible.

**What came next?**

The waking up of the sleeping beauty. A key role was played by Fritz Speck who – as a long-time and brilliant engineer at Bureau BBR – knew the company and its potential well. He became co-shareholder and, joined by Pietro Brenni, we started to rejuvenate BBR by founding own companies in Poland, Croatia, Singapore and other countries and by buying into local BBR licensees, such as in New Zealand and India.

**Despite great successes, especially in Singapore and Poland, you changed strategy after the turn of the century. Why?**

Firstly, within this new set up, BBR was confronted with the pros-and-cons of being exposed to project risks in multiple countries with differing dynamics. An example is the Rama VIII bridge in Bangkok, a ‘divine’ dream structure – but a most complex project on all possible fronts which gave us some headaches for many years! We had to realize that construction would always remain a local business – irrespective of what kind of sophisticated technology you apply and what brand you represent. Secondly, as our focus was on building structures with BBR technology globally through our own subsidiaries, the investment into the BBR brand and the rejuvenation of the technology itself stalled. It was as though the sleeping beauty we had woken up was dancing at too many parties! We had to decide in which direction to go – an own worldwide BBR Group without any licensees, or the BBR Network route, with Franchisees worldwide. We came to the conclusion that a BBR Network solution could only work with the support of some Network Members. The licensees were, quite rightly, very skeptical – as they did not get any particular support from BBR and were eyeing BBR as a competitor which was potentially challenging them for the post-tensioning business in their countries.

**Looks like a tricky situation to get out of?**

Indeed. There was only one way forward, we had to make a radical change. So, we changed our strategy, set-up and modus operandi. ➤



1

“We had to realize that construction would always remain a local business – irrespective of what kind of sophisticated technology you apply and what brand you represent.”

“The principle of entrusting young talent with full authority, responsibility and independence is a key success factor in the Tectus Group of Companies and in BBR.”

**But how did you convince licensees of this new approach?**

We were lucky because everybody had to optimize costs. The fact that European Technical Approvals were required for BBR technology – at a price European BBR licensees could not afford individually – became the key catalyst. BBR licensees in Austria, Poland, Scandinavia and Spain joined forces, together with BBR Holding who contributed brand, technology and international licenses to create BBR VT International to share the cost of developing totally new PT and stay cable systems, securing European approvals and setting up a supply chain including the respective quality management systems. And so the BBR Network story and the relaunch of BBR started. We were lucky to secure the appointment of Marcel Poser who took on the demanding task of creating the BBR Franchise, with all its facets, literally from scratch – but building on a reputable brand and a long history.

**How was your relationship with your father in law, Antonio Brandestini, during the process of radical change in BBR and the other family companies, after you took the lead?**

We had an excellent relationship. I like complex and difficult situations and perform best when facing such challenging constellations – but only if I can act with full authority, speed and often proceeding with a ‘thinking outside the box’ approach. I like to take responsibility and to make decisions.

My father in law gave me full and unlimited authority and put full trust in my capabilities, talents, ability to analyze, judge and decide. We regularly discussed the state of the business and the material changes in strategy and operations – and there were many difficult decisions to take – affecting people, set-up and structure. He fully endorsed the changes and new developments proposed, as did the entire Brandestini family – and indeed their support and approval for my leadership and direction continues.

**Did experience of this way of working influence how you operate today?**

The principle of entrusting young talent with full authority, responsibility and independence is a key success factor in the Tectus Group of Companies and in BBR. In all our companies, you will find talented and dedicated people, who have been entrusted with a lot of responsibility and authority.

Without doubt, an important factor in the continuous trust and endorsement of my entrepreneurial activities by my family has been a sustainable performance and creation of value. For sure, success was and is regularly accompanied by the investment of much sweat equity, this is natural and okay – as long as we learn from mistakes and are able and prepared to move out of dead ends. I am happy to see that this working and management style has become fundamental to the success within both the Tectus Group and BBR.





3



4

- 1 Key players in BBR's rejuvenation – Fritz Speck (top) and Pietro Brenni (bottom).
- 2 BBR's experience of an 'own build' approach for Bangkok's Rama VIII Bridge prompted the recognition that construction would always remain a local business, irrespective of what kind of sophisticated technology you apply and what brand you represent.
- 3/4 Antonio Brandestini – he fully endorsed the changes and new developments proposed. Now, he would be eagerly awaiting BBR's centenary celebrations.

#### How do you see BBR's future unfolding?

My ambition was to make, out of BBR, an attractive business for all stakeholders – in a safe and independent operational mode – and secure stable continuity. As BBR VT International is no longer exposed to operational project risk, it can focus exclusively on creating value for the BBR Network with new technologies, products and services, optimizing cost and adding additional revenue for every Franchisee. With the new business format and strategy, I am certain that we will see not only BBR VT International, but also our Franchisees, developing well and safely for many years to come. The shape of the BBR Network – as an international franchised group of specialists – is very exciting and an ideal vehicle for the generation of new ideas.

#### One last question – what would your father-in-law say today, if he were participating in the BBR Network's 70th Anniversary celebrations?

In his typical style as a Honorary Chairman and Co-Founder, he would be delighted to welcome the entire BBR family and guests from all over the world and would be very happy to see familiar faces, as well as so many new young faces.

He would be proud to say that BBR operates a state-of-the-art business within an efficient worldwide franchise model – unique for this industry – and that the BBR Network has been applying BBR technology all over the planet for 70 years now. He would wish us a very enjoyable evening – while making his speech, he would be looking forward to the dinner and lively exchanges of memories and new plans... and anticipating, even more eagerly, the celebrations of the BBR Network's centenary.

On this note, I would also like to add my thanks and congratulations, on behalf of BBR and the Valsangiacomo-Brandestini families, to everybody who has – since 1944 – contributed to the business, making it possible for us to now celebrate BBR's 70th Anniversary. ●



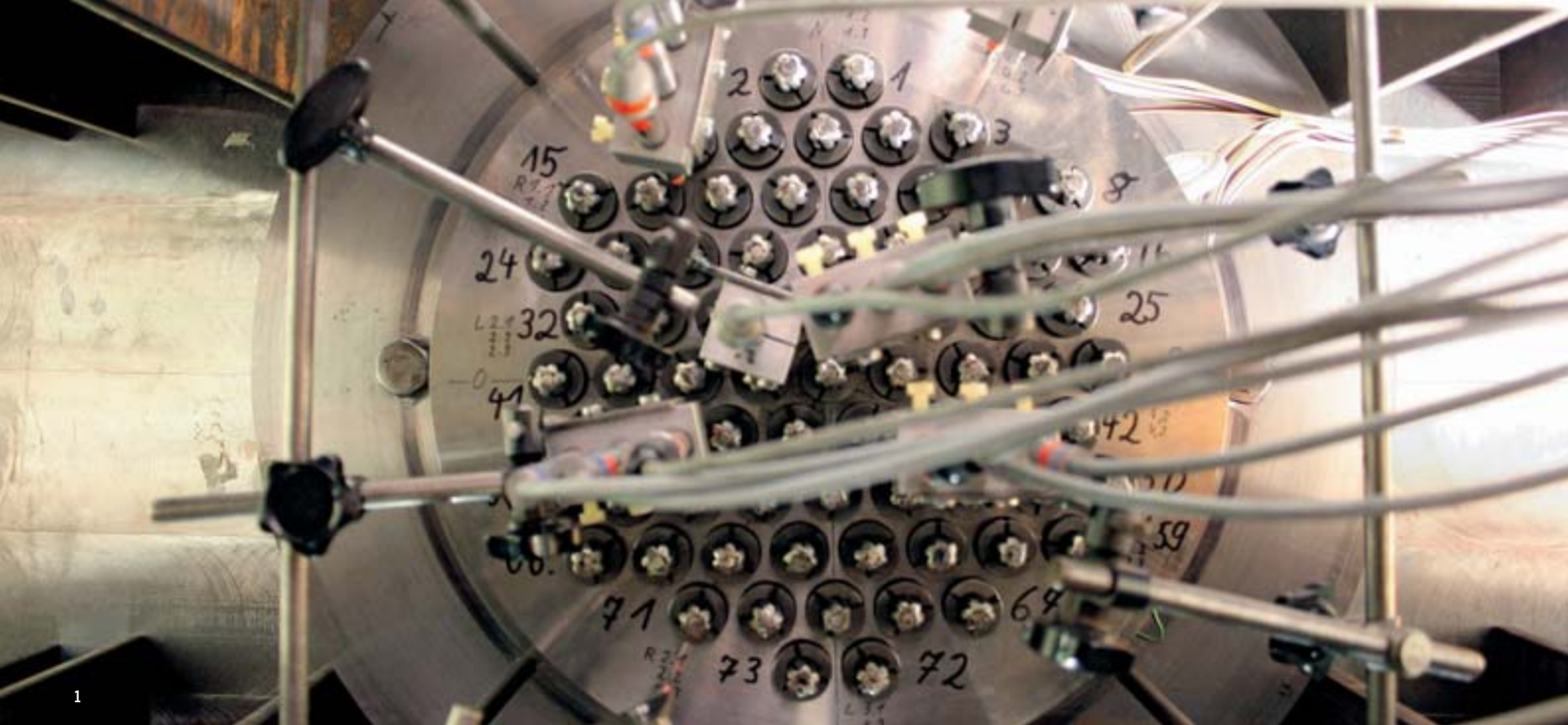

## BBR TECHNOLOGIES & EXPERTISE

Continuous dedication to finest engineering solutions

# ALWAYS ONE STEP AHEAD

The BBR commitment to deliver the finest technology solutions is founded on dedication and deep engineering excellence – this began 70 years ago and still continues today. As times and needs advanced, BBR engineers have always listened to what customers wanted and produced the technology to satisfy their needs.

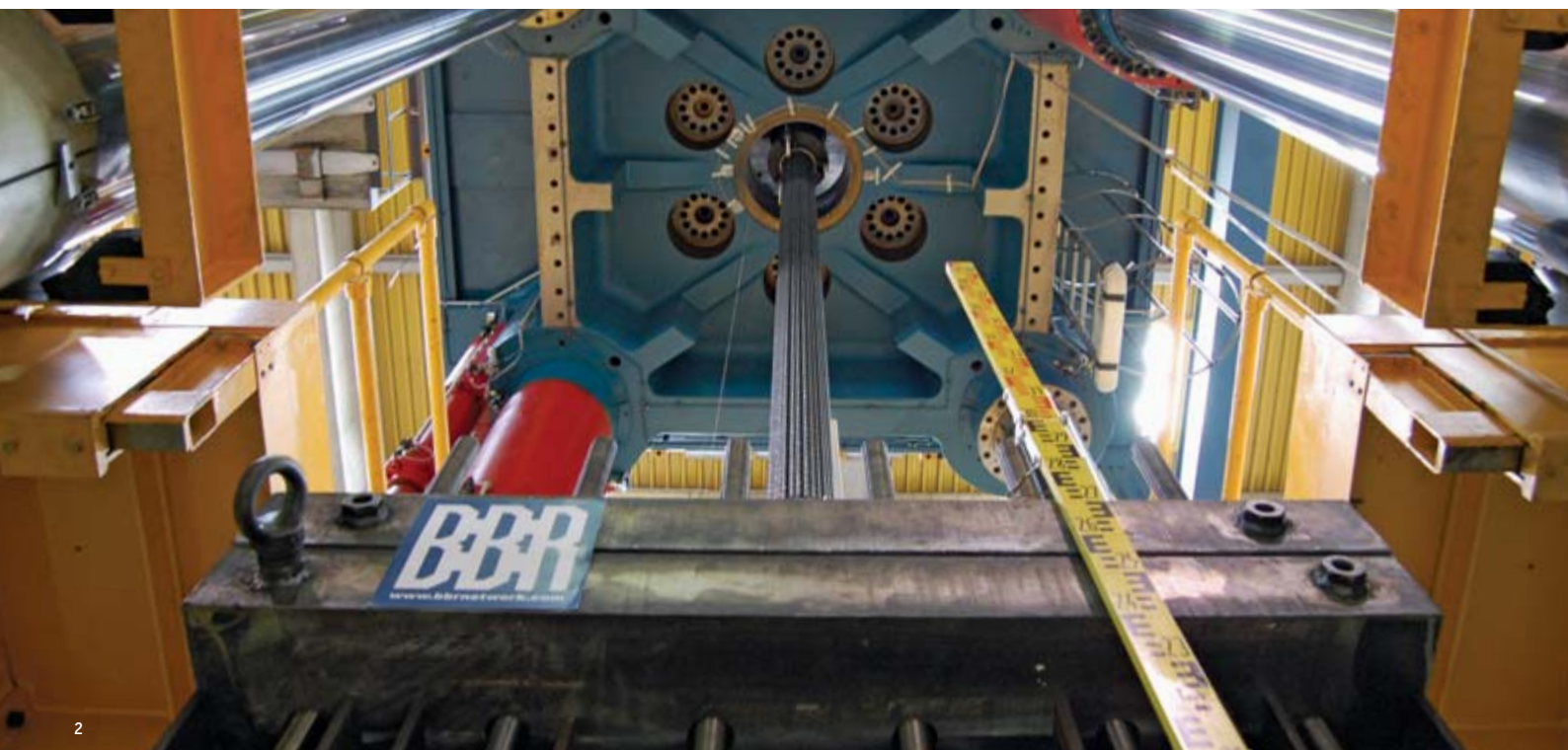

The first piece of construction technology to feature in the BBR portfolio was the 'Stahltonbrett' – a post-tensioned small beam or lintel. This invention was a response to materials scarcity during the Second World War.

By 1947, development of the BBRV cold formed button-headed anchorage was underway. When launched on the market, it was the only anchorage with such a high capacity – and thus became the system of choice during post-war reconstruction.

### Pioneering developments

In the years which followed, the team developed Stahlton-BBRV ground anchors, BBRV tank and pipe winding techniques and equipment and, in conjunction with a German firm, the prestressed Thosti-BBRV railway sleeper (see page 55) aimed at the busy railway reconstruction market place. The prestressing of nuclear power vessels and outer containments began in 1965 and saw a full-scale nuclear tendon testing facility constructed at the Stahlton plant. Meanwhile, in 1958 the BBR wire stay cable system had been used for the first time on the Schillersteg bridge in Stuttgart, Germany. This was to lead to further pioneering BBR developments enabling construction teams to be the first to use BBR strand stay cables (1968) and first to use BBR Carbon stay cables (1994). In 1970 and 1975 respectively, the BBR HiAm (high amplitude) anchor and BBR DINA anchors were launched, both with the vision of delivering the best possible technology to the construction industry. 1992 saw the introduction of the BBR CONA STAY system – and then, in 2008, came the jewel in the crown, the BBR HiAm CONA strand stay cable system.

To improve the performance of their systems still further, the team launched the BBR Pin Connector, BBR Square Damper and, most recently, in 2011 the BBR HiEx CONA Saddle.

### R&D, testing and certification

Extensive research, testing and development efforts place the BBR Network at the forefront in the field of post-tensioning, stay cable applications, ground anchors and related engineering technology. Through our testing and certification process, we have secured European Technical Approval, as well as a range of national approvals, for our BBR VT CONA CMX post-tensioning systems which carry CE marking so that customers can be sure they have a certified product.

### Quality and education

Stringent quality control procedures are applied, supported by BBR E-Trace – our bespoke platform which facilitates the everyday work of all BBR Network Members and also assists effective supply chain management. A culture of continuous education within the BBR Network ensures a high quality execution of post-tensioning and associated work for our customers. BBR Headquarters continuously educates the PT Specialists in post-tensioning and stay cable technology – covering systems, quality assurance procedures and correct installation techniques. ●

## BBR TECHNOLOGY HIGHLIGHTS

- 1946 Stahlton beams and lintels
- 1947 BBRV® cold-formed button-headed anchorage
- 1952 Stahlton-BBRV ground anchors
- 1952 BBRV tank and pipe winding
- 1956 Thosti-BBRV sleepers
- 1958 BBR® wire stay cables
- 1965 Nuclear power vessel & containment prestressing starts
- 1968 BBR strand stays
- 1970 BBR HiAm®\*\* anchors
- 1972 BBR CONA® strand PT system
- 1975 BBR DINA® anchors
- 1994 BBR Carbon stay cables
- 1996 BBR Carbon external PT system
- 2006 BBR VT CONA CMI internal PT range
- 2008 BBR HiAm CONA strand stay cable system
- 2011 BBR HiEx CONA Saddle
- 2012 BBR VT CONA CMF flat PT system
- 2013 BBR VT CONA CMM Single PT system

\*developed in association with Leonhardt Andrä & Partner

- 1/2 Extensive research, testing and development efforts place the BBR Network at the forefront of construction engineering technology – supporting the development of a range of products which have become international benchmarks.
- 3 The BBRV cold formed button-headed anchorage offered the highest capacity for PT and became the system of choice for post-war reconstruction.
- 4 As early as the 1960s, BBR engineers were testing high capacity PT tendons for nuclear applications.



3



4



# STATE-OF-THE-ART POST-TENSIONING WITH BBR VT CONA CMX

The BBR Network offers a complete range of post-tensioning systems, covering all possible applications in structural and civil engineering.

Developed in Switzerland, the European approved and CE-marked BBR VT CONA CMX PT range – the PT system for the 21st century – is used worldwide by the BBR Network. Our certified BBR PT Specialists ensure professional execution of PT and grouting works.



## BBR VT CONA CMX

The newly developed BBR VT CONA CMX family has been tested to the most stringent international testing specifications – those of the European Technical Approval Guidelines ETAG 013. Its modular design means that a CONA CMX PT kit can easily be configured to match special requirements. All systems are subject to Factory Production Control (FPC), as well as independent and continuous surveillance. All CONA CMX kits must be installed by trained BBR PT Specialist Companies only, ensuring a professional and system-conforming installation. All requirements are strictly followed by the BBR Network and ensure the highest level of product quality and installation, including best health and safety standards.

- The CONA CMI internal bonded or unbonded post-tensioning system is internationally the most up-to-date and advanced multi-strand PT technology, ranging from 1 to 73 strands.
- The CONA CME external post-tensioning system is the ultimate multi-strand technology for all types of externally post-tensioned applications. The standard tendon sizes range from 1 to 73.
- The CONA CMF flat anchorage post-tensioning system (bonded or unbonded) is a multi-strand technology for internally post-tensioned applications where the anchoring has to be carried out in very thin concrete cross-sections, such as slabs. The standard tendon sizes range from 2 to 4 strands.
- The CONA CMM Single post-tensioning system is an internal system with one strand for unbonded or bonded applications.
- The CONA CMM Two and Four post-tensioning system is a monostrand system for internally unbonded applications. The standard tendons have 2 or 4 strand configurations.
- The CONA CMB band post-tensioning system is a multi-strand technology for special external and also internal unbonded post-tensioned applications. The standard tendon configurations range from 1 to 16 strands.

## BBR VT CONA CMX

### Key benefits

- Modular system
- Most compact and lightest anchorage system
- Full stressing at lowest concrete strength
- Widest range of standard tendons – ranging from 173kN to over 20,000kN characteristic ultimate resistance
- Most comprehensive range of systems and tendon sizes

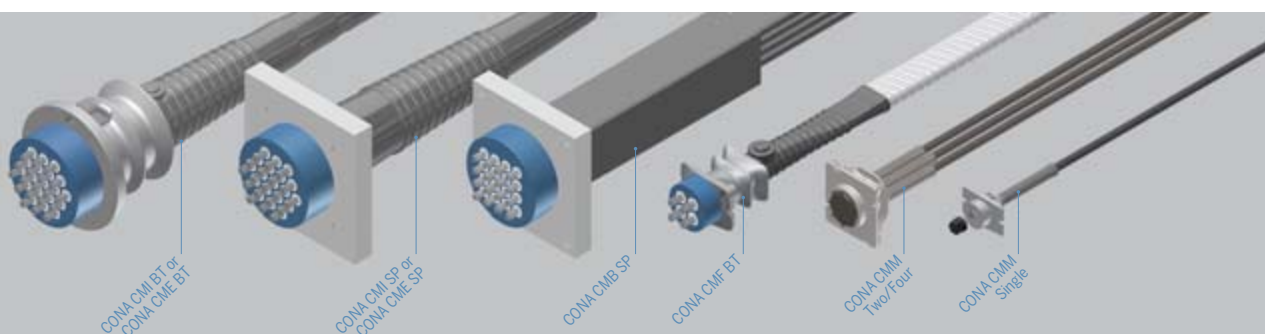





1

### Other BBR PT systems

The BBRV wire cable post-tensioning system is one of the earliest and most reliable. This parallel wire system was developed by BBR in 1944 and has since been continuously advanced. Furthermore, the CONA compact, CONA multi, CONA single, CONA flat and CONA external strand post-tensioning systems have been applied very successfully for many decades. As a result of BBR's continuous R&D and focus on excellence, architects, owners and developers worldwide are now enjoying the cost and time savings, as well as the flexibility and freedom of design, that adopting a post-tensioned approach offers.



- 1 Post-tensioned floor slab for a 32,000m<sup>2</sup> distribution center for a large superstore retailer in New Zealand.
- 2 The BBR VT CONA CMM unbonded post-tensioning system was used in the construction of digestion tanks for the Gut Grosslappen Wastewater Treatment Plant in Munich, Germany.
- 3 BBR holds the record for the longest permanent ground anchor ever installed – at over 142m in length.



2

### BBR ground anchors

One of the early civil engineering applications of BBR prestressing technology was for anchoring structures into the ground and for stabilizing slopes using ground anchors. Since then, BBR ground anchors have evolved significantly and our latest milestone – the CONA CMG strand ground anchor – has benefitted a wide range of customers. BBR CONA soil and rock anchors, BBRV wire ground anchors, special high capacity and electrically isolated ground anchors, PT bars, soil nails, rock bolts and micropiles complete the range.



3

CONA CMG anchors are currently available in capacities from 260kN to 25,390kN ultimate breaking load (from 1 to 91 strands), and in a wide range of options with regard to corrosion protection and geometry. We offer temporary anchors when the service life of the anchor is limited to less than two years. Removable anchors are specified when temporary anchors cannot be left de-stressed in the ground. Permanent anchors are designed with very high levels of corrosion protection for a 100+ year design life, which sets them apart from their temporary counterparts. In fact, BBR anchors hold the record for the longest permanent ground anchor ever installed at over 142m in length!

BBR ground anchors fulfill EN 1537 standards or latest regulations in force at the place of use. CONA CMG ground anchors share componentry with European approved CONA CMX PT systems and thus benefit from a stringent regime of testing and quality assurance under the ETAG 013 requirements for post-tensioning kits. ●



1

## BBR TECHNOLOGIES & EXPERTISE

---

Newest and most versatile stay cable technology

# RELIABLE AND FLEXIBLE BBR STAY CABLES

Many of the most dramatically beautiful architectural designs and technically excellent feats of engineering have been realized with the use of state-of-the-art Swiss BBR stay cable technology. The BBR HiAm CONA strand stay cable system, BBR HiEx CONA Saddle technology for extradosed applications and the BBR HiAm/DINA wire stay system are unrivalled anywhere on the planet and have been applied to more than 420 projects.

### **BBR HiAm CONA strand stay cable system**

HiAm CONA fulfills the latest international standards and recommendations deemed approved and compliant with *fib* as well as the corresponding PTI and Setra recommendations. Its wide range up to 217 strands, tendon capacity from 200 to 60,000kN, advanced water tightness, high corrosion protection, simple installation and superior fatigue resistance makes it attractive for the most challenging of projects.

Designers and architects have particularly welcomed the compactness of the anchorage system which allows them greater scope to produce a sleeker and more striking structure. HiAm CONA is

subject to BBR Factory Production Control and must be installed by certified BBR PT Specialist Companies only. The system can be used for cable-stayed bridges, arch bridges, roofs and also special applications like towers.

The BBR HiEx CONA Saddle system represents the newest and most modern saddle for stayed and extradosed bridges. The HiEx CONA Saddle system completely eliminates the problems associated with standard friction saddles and, at the same time, allows for a compact and slender pylon. The technical solution results from the combination of the CONA CMI internal PT system with the BBR HiAm CONA strand stay cable system.



The BBR HiAm CONA Pin Connector is the perfect blend of strength and beauty, while at the same time it extends the inherent benefits of the BBR HiAm CONA family. The BBR HiAm CONA Pin Connector is a beneficial solution for stay cable structures where it is necessary to simplify the end connection detail or to have a certain rotational capability along a specific axis. Due to its simple design, high efficiency, easy adjustability and low maintenance requirements, the BBR Square Damper is simply the most superior damping device available on the international market. The BBR Square Damper incorporates a new generation of materials, together with a ventilation / insulation system to enhance the durability of the components and to extend maintenance intervals.

**BBR HiAm/DINA wire and BBR Carbon stay cable systems**

BBR was not only the pioneer and inventor of the high amplitude fatigue resistant ‘HiAm’ wire stay cable system composed of 7mm wires, we also constructed the world’s first project using such technology. The patented BBR Carbon stays have an exceptionally high fatigue strength – up to 10 million load cycles with 250MPa – combined with light weight, corrosion-free properties. Always focused clearly on future needs, BBR continues to develop and refine its technology to meet contemporary requirements – often exceeding specifications of international guidelines and codes. ●



2



3



4

**BBR HiAm CONA**

**Key benefits**

- Tendon capacity 200-60,000kN
- Superior fatigue resistance
- Advanced water tightness system
- High corrosion protection
- Compact anchorage and cable
- Simple installation
- Easy and low maintenance

- 1 One of Europe’s widest cable-stayed bridges, the Basarab Flyover Bridge in Bucharest, Romania, was constructed using BBR VT CONA CMI internal post-tensioning and BBR HiAm CONA stay cables.
- 2 The BBR Square Damper is a superior supplemental passive friction-based damping device which can be installed to counter the effects of stay cable vibration.
- 3 The BBR HiAm CONA stay cable system fulfills latest international standards and has a wide range of up to 217 strands, tendon capacity from 200 to 60,000kN, advanced water tightness, high corrosion protection, simple installation and superior fatigue resistance.
- 4 The Saujana Bridge in Kuala Lumpur, Malaysia is a unique structure because the deck is supported by a hybrid system of arch and stay cables.



# ENGINEERING EXCELLENCE IN BRIDGE CONSTRUCTION & HEAVY LIFTING

The BBR Network provides excellence in all categories of bridge construction techniques whether for cast-in-situ applications or precast construction.



We offer the whole range of expertise from preliminary design to execution for balanced cantilever, incremental launching, advanced shoring (Movable Scaffold System – MSS), span-by-span techniques and related methods, and maintain a complete range of bridge construction equipment. In addition to bridge construction techniques, we provide heavy lifting engineering and operations for extremely heavy loads.

#### **Balanced cantilever**

The proven and safe balanced cantilever method, as used by the BBR Network, is often appropriate and cost-effective for the construction of long span cast in-situ or precast concrete bridges including various landmark structures where height, topography or geotechnical conditions render the use of conventional formwork uneconomical. The economical range of span lengths for cast-in-situ cantilever construction begins at roughly 70m and extends to beyond 250m. Considerable savings can be achieved by using this method, rather than conventional bridge construction.

#### **Incremental launching**

Incremental launching of bridges can save time, money, space and disruption while easing access and delivering a high quality finish. The incremental launching method is particularly suited to the construction of continuous post-tensioned multi-span bridges. It involves casting 15-30m long sections of the bridge superstructure in a stationary formwork behind an abutment and pushing a completed section forward with jacks or a friction launching system along the bridge axis. The sections are cast contiguously and then stressed together. The superstructure is launched over temporary sliding bearings onto the piers. To keep the bending moment low in the superstructure during construction, a launching nose is attached to the front of the bridge deck.

#### **Advanced shoring**

The advanced shoring method – or Movable Scaffold System MSS – has been developed for multi-span bridges over difficult terrain or water where scaffolding would be expensive or simply not feasible. A launching girder moves forward on the bridge piers, span-by-span to allow placing of the cast-in-situ concrete. The method – both underslung and overhead – is highly adaptable for a wide range of spans and types of superstructure. The travelling gantry system is most suited for spans of 30 to 60m. ►



2



3





4



5

**Precast span-by-span**

The precast span-by-span bridge construction method offers a very high speed of construction. It is most often used in conjunction with an erection truss under the bridge segments or an overhead erection gantry to guide the precast elements into position. Since there is only one cycle of stressing and grouting of tendons per span, the method can be significantly faster than precast balanced cantilever construction, which requires one such cycle per pair of segments.

The most common use of span-by-span construction is to build long viaducts with spans of similar length. The method has been used most often for spans ranging from 25m to 45m. As spans increase, there is a significant increase in the cost of the erection girder. The erection girder can support the segment from below, or above – underslung and overhead launching gantries.

Alternatively, full-span precast beams can be delivered from the precast beam production to the erection front by the launching gantry. This method allows a fast rate of erection.

**Heavy lifting**

Heavy lifting is a specialist hydraulic cable lifting technique developed for exceptionally heavy loads and used by BBR Network Members. The technique provides a particularly timely and economic solution for projects based on modular construction methods and large, heavy, prefabricated elements. The heavy lifting technique can be used for:

- Lifting and lowering of heavy loads – including precast beams, entire structural elements, roofs and falsework which have been built on site or at a factory and are lifted in place by means of strands and hydraulic jacks
- Lifting of bridges – for the exchange or repair of bridge bearings for instance, the superstructure is lifted and lowered with hydraulic jacks without disturbing traffic
- Rotating and sliding of bridges – a bridge structure can be rotated or slid from the assembly area to its final position. ●

- 1 The incremental launching method was chosen for construction of the 1,176m long 18-span Barbantiño Viaduct in Galicia, Spain because of the rough terrain and great height of the piers.
- 2 Grudziadz Bridge, Poland – formwork travellers were used in the construction of the three span cantilever section of this almost two kilometer long bridge.
- 3 Viaducts in Villena-Sax, Spain – span-by-span construction, using a Moveable Scaffold System, was employed to construct these new motorway viaducts.
- 4 The BBR Network Member in Malaysia is delivering launching and prestressing work for both packages of Kuala Lumpur’s 17.3km Light Rail Transit system extension project.
- 5 For the Eastlink project in Melbourne, Australia, a new rail bridge was ‘slid’ into position, using heavy lifting techniques, in just a few hours.



# GIVING NEW LIFE TO STRUCTURES

The BBR Network offers a wide range of specialist Maintenance, Retrofit and Restoration or Renovation (MRR) technology which delivers leading edge green and economic solutions in our cost-conscious and environmentally aware world. Such MRR techniques include fiber reinforced polymer (FRP) application, bearing replacement, external post-tensioning and Impressed Current Cathodic Protection ICCP.



1 Seismic strengthening work was carried out by BBR Contech to the Kawarau Bridge, near Queenstown in New Zealand.

In addition to the techniques mentioned, other specialist procedures are used by BBR Network Members. They are able to provide all the necessary engineering support, have the knowledge, skills and resources, as well as equipment and material to satisfy almost all project needs.

## **Fiber Reinforced Polymer**

Additional shear capacity, flexural strength and ductility can be applied to beams, columns, slabs and walls by the application of FRP materials – with minimal disturbance to occupancy and rentable asset space.

## **Bearing replacement**

Replacing bridge bearings, when they have reached the end of their design life, requires the development of precise procedures and the application of heavy lifting techniques – jacking – to raise the bridge deck to allow removal and insertion of bearings.

## **External PT strengthening**

The use of externally placed post-tensioning tendons to increase load carrying capacity is a well-established well-established practice, mainly used for bridges. External post-tensioning can also be applied to buildings to increase structural strength. CONA CME external tendons are the right solution for such applications.

## **Impressed Current Cathodic Protection**

Impressed Current Cathodic Protection (ICCP) systems are installed to inhibit the corrosion of steel reinforcing bars in concrete structures – particularly if the latter are in aggressive marine environments. The ICCP control system monitors and records performance.

The expertise of the BBR Network in the area of maintenance, repair and retrofit or renovation is founded on a long experience and understanding of structures, as well as the professional, effective and safe application of the latest technologies. Members of the BBR Network can also supply and install further technologies such as bearings, joints, PT bars and the BBR WIGABlock load cell which is typically used, among other applications, for calibrating hydraulic jacks, stay cable monitoring, bridge load control on abutments and pylons, ground anchor and wind tower stress monitoring. ●

# 21<sup>ST</sup> CENTURY RENAISSANCE

Since it was founded, the BBR business has undergone a major transformation – designed to reflect modern needs and those of the future. Thomas Richli, Chief Business Development Officer at BBR VT International Ltd, describes how this renaissance has involved both the creation of completely new technology and the implementation of an innovative business structure – the BBR Franchise.

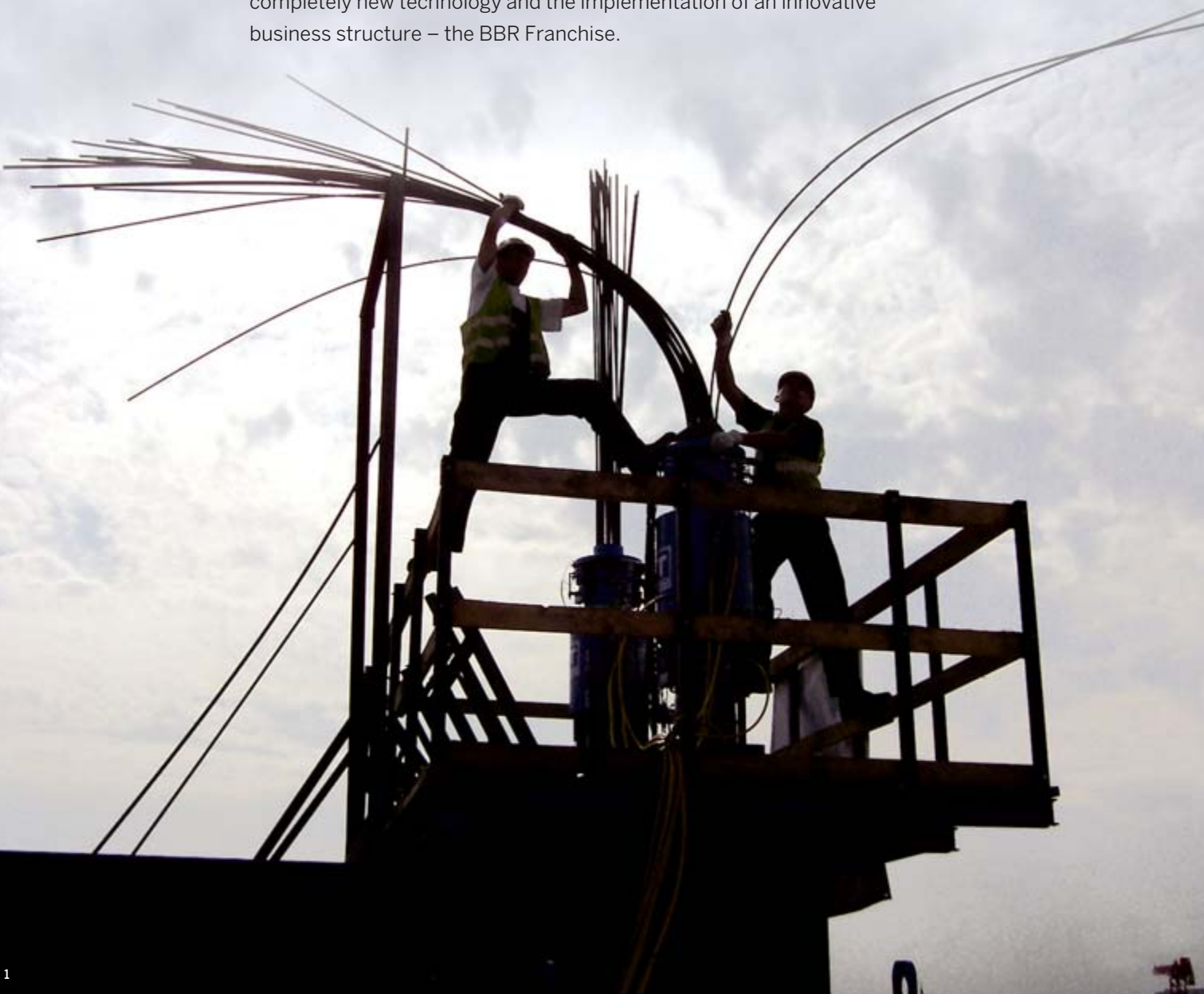

BBR was founded in the 1940s and had successfully traded with innovative technology and highest service standards on the international construction scene for many years. In 2006, the BBR Franchise and the Global BBR Network were born – and have since then grown in terms of not only the number of countries covered, but also business volume. Today, it is the largest franchise of its kind in the world and we are committed to further strengthening it – both geographically and with new services and technology.

**How did the BBR Franchise come about?**

The BBR Franchise developed from the earlier BBR technology licensing business and was our direct response to two challenges. Firstly, we identified the need for strong local knowledge in countries of operation – so needed fully committed, exceptionally good local contractors and expertise to implement BBR technology while continuing to ensure the highest level of quality and service for clients. Secondly, a change in European legislation – with the introduction of Eurocodes and European Products Directive – required European approved post-tensioning systems based on stringent testing requirements and extensive approval and certification procedures. Rather than just modifying our existing range, we wanted to bring a whole new set of technology – reflecting the very latest in design and capability – to the world market. By adopting a franchising approach, we could share costs and maintain a clear business focus for both parties – the Franchisor’s obligations to provide latest technology and marketing tools, plus the Franchisees’ responsibilities to use and market our products concentrating on service excellence.

Thus, BBR VT International committed to making a multimillion Euro investment into the development, testing and approval of the CONA CMX post-tensioning range and to provide it to the Franchisees. Then, just two or three years after that, the new HiAm CONA stay cable system was introduced – also tested to latest standards – and made available to our BBR Network Members. Over the last eight years, the BBR Network has expanded and now covers some 50 countries, with some 1,000 professionals and over CHF200 million revenue in core business.

**What exactly is a BBR Franchise?**

A BBR Franchise is an agreement between two legally independent parties – with BBR VT International Ltd as the Franchisor and a local business, the BBR Franchisee, who both agree to maintain a close and continuous cooperation over a long term. BBR VT grants a Franchisee the exclusive right to operate in a specified area (called territory) – to use the know-how and to market BBR post-tensioning, stay cable and related construction technology, products and trademarks. The Franchisee agrees to actively conduct promotion and marketing, order components only from certified BBR manufacturers, follow quality management and reporting instructions and regularly attend training sessions and conferences – as well as to pay the franchise fee. In basic terms, the BBR Franchise is a distribution channel through which BBR construction technology, brands and services are marketed. However, the BBR Network is actually very much more than this – it is a strong, international community working towards common goals.

**Who are BBR Franchisees?**

The BBR Network is a diverse group of construction companies, each with strong local roots, ranging from global contractors to specialized post-tensioning entities. Our Franchisees are all established specialized contractors with the necessary trained staff, knowledge, experience, equipment and processes with strong local roots. With most of the Franchisees, we have long-term relationships – some stretching back for over 50 years! ▶

**ADVANTAGES OF THE BBR FRANCHISE MODEL**

- The BBR Franchise provides our Franchisees with a certain level of independence where they can operate their business.
- The Franchise provides an established technology with brand names that are recognized throughout the world.
- It offers start-up assistance with special introductory training and marketing activities.
- Franchisees benefit from on-going training and support.
- Up-to-date and standardized promotional material provides all information needed to use BBR products in the market place.
- Collective purchasing power secures preferential prices for components and materials.
- Research & Development provided by the Franchisor enables on-going development and improvement of BBR systems and products.
- Association and synergies between Franchisees allow sharing of resources, equipment, risk and knowledge for special and large-scale projects.
- Franchisees offer clients and contractors the very latest technology and a quality and consistent service.
- Clients benefit from local presence and knowledge that the Franchisee is backed by a globally trading group and international expertise for special or large-scale projects.







2



**What makes the BBR Network so strong?**

There are a number of factors here – and they go way beyond the fundamentals of legally-binding franchise agreements. The construction technology, services and BBR trademarks provided by us are proven, well-known and backed by decades of experience in the industry. Our brands stand for state-of-the-art, approved, Swiss quality products installed by certified, trained and experienced local PT Specialists – the Franchisees.

The BBR Network also draws strength from the continuously growing sense of ‘family’ felt among Members. Good communication is at the heart of this. We offer a variety of channels – including conferences, workshops, training sessions, on-site marketing visits or activities and interactive task groups, newsletters and an e-commerce platform. These provide a forum for the exchange of views, sharing of best practice and experiences, while also identifying market needs – plus opportunities to get to know other BBR Network Members informally. As well as these benefits, global collaborations create local competitive advantages in working within the ever-changing construction market place. The BBR Network has grown into a major global enterprise, with members supporting each other and, in turn, reaping the commercial benefits of both the leading-edge technology and international outlook.

**How will we further strengthen the BBR Network?**

Our emphasis will be investing further in training, new communication tools, sharing resources, knowledge, best practice and networking. We will join forces to tackle large projects around the globe which a single Franchisee would not have the resources to complete alone, optimize our supply chain and quality management processes. We will also see a wider spectrum of offerings including a globalization of the full range of techniques and expertise within the Network.

**How do companies become BBR Network Members?**

We have a well-established process for membership application and assessment. Once membership has been agreed, we audit our Members annually to ensure that quality standards continue to be maintained. The BBR Franchise is unique in the construction market place and offers a wide range of opportunities for the Franchisees supporting the development of their local businesses. We are very proud of our international family and enjoy working with them to realize some of the most challenging projects in the world. We share and endorse their professionalism and commitment to the highest standards of customer service. ●

- 1 Today, the BBR Network is the largest franchise of its kind in the world and it is being further strengthened – both geographically and with new services and technology.
- 2 The BBR Network also draws strength from the continuously growing sense of ‘family’ felt among Members – through exchanging new, best practice and know-how at events, such as the Annual Global BBR Conference held in Paris in 2009.

**JOIN THE BBR NETWORK**

To find out more about the opportunities offered by a BBR Franchise, please contact BBR VT International Ltd, Technical Headquarters and Business Development Centre at [www.bbrnetwork.com](http://www.bbrnetwork.com).

# IN THE BOARDROOM

Around the boardroom table at BBR VT International – the Franchisor of the BBR Network – are key individuals with not only first-hand experience of working with customers and BBR technology, but also a wealth of broader experience and global vision gained at senior level within international groups. This arrangement ensures that the BBR Network continues to offer a competitive, committed and relevant approach to the market place. Here, we explore the shareholder organizations and the people behind this successful management structure.

## Investing in excellence

Based in Zurich, Franchisor BBR VT International Ltd (BBR HQ) is the Technical Headquarters and Business Development Centre of the BBR Network. This is where marketing support activities, as well as research and development, takes place. BBR HQ is steered by a Board of Directors – drawn from shareholder organizations – who shape the longer term, high level strategy which BBR HQ implements on a day-to-day basis.

The three major groups forming the shareholders of BBR VT International Limited are the Tectus Group, KB Group and FCC Group – all have a diverse range of business interests, both within the construction sector and also in other fields.

Their considerable reach geographically and financially gives additional strength and perspective to the BBR Network and its operations.

Shareholder organizations also have an active interest as they have BBR Network Members among their subsidiaries. By drawing key individuals from these shareholders – and sometimes their parent companies – to sit on the Board of Directors, additional experiences can be brought into the direction and development of the BBR Network's business. ►







1

### On the Board

It is widely recognized that it is the people themselves who make the greatest impact on the success of an organization.

Accordingly, we would like to acknowledge here the experience and support which currently eight individuals from shareholder organizations are giving to make the BBR Network even stronger and even more successful.

BBR VT International's Board of Directors is currently chaired by Marcel Poser – a familiar face, he is the former CEO of BBR VT and now works as Group CEO of BBR Holding Limited's parent company, Tectus. Bruno Valsangiacomo has also served on the BBR Board for a number of years.

Many people will know Bruno – a seasoned corporate banker and entrepreneur with interests in various industries in Switzerland, Poland and the Far East – for his successful business approach across many market sectors. Both Marcel and Bruno are based in Switzerland, as is financial wizard and fellow BBR Director, Peter Ekberg. Peter is Chief Financial Officer of the Tectus Group and, through KPMG and subsequent appointments, has gained a broad view of financial management on an international scale. Vice Chairman of BBR VT's Board is José Manuel Illescas who has been a Board Member of BBR PTE since 2008 and now heads FCC's construction machinery division. José Manuel developed expertise in bridge technology and various other concrete structures early in his career. He now brings over 20 years' experience in post-tensioning and specialist construction

techniques – some of this time as CEO of BBR PTE – to the boardroom table. Also from Spain, comes Fernando Tejada.

The CEO of BBR PTE since 2008, Fernando has much techno-commercial knowledge of concrete structures and formwork, as well as of on site concrete construction and prefabricated precast manufacturing and construction.

A further two Board Members – Svein Finstad and Tore Thorstensen – come from Norway's KB Group. Tore Thorstensen is CEO of KB Gruppen Kongsvinger AS (KB Group) and has a background of senior roles within the industry.

Meanwhile, Svein describes himself as an 'aspirant' engineer and has almost four decades of senior management positions within the Scandinavian construction industry. Currently, he is CEO of Spenneteknikk International AS, parent company of KB Vorspann-Technik, KB Spenneteknikk and BBR Polska.

Svein is also Chairman of BBR Polska (Poland), KB Vorspann-Technik (Germany) and KB Vorspann-Technik (Austria). Erling Strøm is the former Chief Financial Officer of the KB Group and, today, having founded his own business, he provides consultancy services to the Group.

The strong shareholder backing, combined with a blend of construction technology expertise and very senior strategic management experience within the BBR Board, will continue to ensure a great future for the Global BBR Network – and, ultimately, the very highest levels of customer satisfaction. ●

1 BBR VT International's Board of Directors (from left to right) – Marcel Poser (Chairman), José Manuel Illescas (Vice Chairman), Bruno Valsangiacomo, Peter Ekberg, Fernando Tejada, Svein Finstad, Tore Thorstensen and Erling Strøm.





**BBR A Global Network of Experts**  
www.bbrnetwork.com

**BBR FRANCHISEES**  
Post-tensioning Specialists  
Independent entities in over 50 countries

- BBR Adria
- BBR Holdings Singapore
- BBR Polska
- BBR Pretensados y Técnicas Especiales
- Canadian bbr
- ETIC
- Huta-Hegerfeld Saudia
- KB Spennetechnik
- KB Vorspann-Technik
- Marwan Alkurdi & Partners
- NASA Structural Systems
- Spanstaal – Ballast Nedam Infra Specialiteiten
- Spänntechnik
- Stahlton
- Structural Systems (Africa)
- Structural Systems (Australia)
- Structural Systems (UK)

**FRANCHISOR**  
Technical Headquarters and Business Development Centre of the BBR Network  
BBR VT International

Shareholder organizations of BBR VT International

TECTUS GROUP	FCC GROUP	KB GROUP
<p>Switzerland</p> <p>Established in 1944 and based in Switzerland, the Tectus Group and associated companies is a family owned multi-national conglomerate holding diverse investments and operating in seven key areas:</p> <ul style="list-style-type: none"> <li>• Construction &amp; engineering</li> <li>• Real estate</li> <li>• Devices &amp; solutions</li> <li>• Biomedical</li> <li>• Lifestyle</li> <li>• Media &amp; entertainment</li> <li>• Advisory</li> </ul> <p>Parent company of BBR Holding * Investments in BBR Franchisees BBR Holdings Singapore and Stahlton</p> 	<p>Spain</p> <p>With roots stretching back over 100 years, the FCC Group was founded in 1992 following the merger of two major construction companies and now operates internationally in three main business streams:</p> <ul style="list-style-type: none"> <li>• Infrastructure</li> <li>• Services</li> <li>• Energy</li> </ul> <p>Investments in BBR Franchisee BBR Pretensados y Técnicas Especiales *</p> 	<p>Norway</p> <p>Established in 1965 under the name Kongsvinger Betongindustri, today the KB Group – purely a holding and property company – is the largest family-owned building and construction company in Norway. The Group's activities include:</p> <ul style="list-style-type: none"> <li>• Property development</li> <li>• Construction</li> <li>• Steel &amp; concrete elements</li> <li>• Specialist &amp; heavy engineering</li> <li>• Ready mixed concrete</li> <li>• Quarrying</li> </ul> <p>Investments in BBR Franchisees KB Spennetechnik, KB Vorspann-Technik and BBR Polska *</p> 

\* Shareholders of BBR VT International



# OUT AND ABOUT

In the 70 years since the foundation of BBR, the whole team has been active on the global scene. For this special anniversary, we have raided the BBR photographic archive and present some of the pictures which capture some of the memorable moments in our history.



◀ **1940s:** The earliest known photograph of the three BBR founders together. Left to right: Antonio Brandestini, Mirko Robin Roš and Max Birkenmaier in the yard of the Keller brickworks in Frick, Switzerland. The Stahlton AG factory, which they built to manufacture BBR technology, is located nearby – see pages 36 & 37 for more details.

▲ **10-20 April 1948:** Max Birkenmaier (left) and Antonio Brandestini (right) on their way into the MUBA Exhibition in Basel where Stahlton AG was exhibiting some BBR technologies for the first time.



◀ **23 May 1958:** Welcome party held by Messrs. Shiraishi Foundation Co., Ltd at Marunouchi Kaikan, Tokyo. Antonio Brandestini and, to his right, Mrs Brandestini are guests of honor – and feature in the center of this group photograph.

▼ **1960s:** Speeches are underway – to the great delight of Antonio Brandestini (right) – at one of the earliest BBR Dinners, this one was held at the Union League Club in Chicago, USA.



◀ **1970s:** During a visit to the King Edward Hospital project in Perth, Australia, with Bob Freedman (left) – who was later to become Chairman of Australian BBR Network Member, Structural Systems – Josef Koch, the Swiss engineer responsible for introducing BBR technologies to the continent, proudly points out the BBR logo on the site signboard.



▲ **1970s:** Josef Koch donned a hard hat to inspect work on Sterling Bridge in Perth, Australia.

▶ **June 1971:** Antonio Brandestini (left) and Max Birkenmaier take time out together to admire the landscape in the Highlands, South Carolina during a trip to the USA.





▼ **2007:** Zelimir Bodiroga of BBR Adria (Croatia), Pietro Brenni former CEO BBR VT and Svein Finstad from KB Spenneteknikk (Norway) are engaged in some lively evening networking during the Annual Global BBR Conference in Singapore.



► **2007:** On behalf of his company, Paul Wymer (right), Managing Director of BBR Contech, the New Zealand based BBR Network Member, accepts the Technology Award from Chris Munn, President of the New Zealand Concrete Society at their Annual Conference. The award was presented for their work for national grid operator Transpower to strengthen the foundations of electricity transmission pylons, enabling them to take additional loads. The Technology Award recognizes outstanding innovation in the advancement of concrete practice in design, construction, rehabilitation or research.



► **2008:** Aiming high – always. Team building activities at the Annual Global BBR Conference included a group ascent of one of Sydney’s most famous landmarks – the Sydney Harbour Bridge. The 3½ hour long climb required the intrepid delegates to tackle 1,332 steps to the summit – proving that the BBR Network is fit for any challenge. Left to right, back row: Marcel Poser, Tommy Lindstrand, Svein Finstad, Thomas Heubel, Hugo Jackson, Peter Higgins. Front row: Paul Wymer, Mrs Iris Finstad, Mrs Margret Heubel, Jeff Marchant, Mrs Anita Jackson, Terry Palmer.



▲ **June 2009:** Diana Cobos Roger, from Spanish BBR Network Member BBR PTE, and much celebrated structural engineer and bridge specialist, Michel Virlogeux were both Keynote Speakers at the Austroads Conference and took time out for a photograph in front of the BBR Contech exhibition stand.



► **2008:** The team from BBR Construction Systems Singapore and Malaysia give a ‘thumbs up’ to the BBR Conference in Sydney, Australia after their climb. Left to right: Lee Chong Whey, Ooi Teik Min, John Mo, Chang Chee Cheong.





▲ **2011:** All in the same boat – literally – for the kick-off of activities during the 2011 Global BBR Conference in Switzerland, BBR's homeland. The team posed for a photograph as their boat sailed around lovely Lake Lucerne. During the evening various achievement awards were presented and delegates had the opportunity to relax and network with colleagues from around the world.

▶ **2011:** Special conference guest, Dr.-Ing. Werner Hanenkamp – technical consultant to BBR VT and member of the Faculty of Construction Engineering at the Ruhr University Bochum, Germany – smiles broadly during the evening boat trip on Lake Lucerne... perhaps the experience brought to mind his work with BBR on the award-winning Monaco Floating Breakwater (see page 57).



▲ **2011:** Intercontinental reunion – Zelimir Bodiroga of BBR Adria (Croatia) renews acquaintance with Yok-Lin Voon of BBR Construction Systems (Malaysia).

▶ **2011:** Another challenge overcome together – Structural Systems Limited's Chairman, Robert Freedman, Wilem Smit – then CEO of Spanstaal – and Jan Piekarski, CEO of BBR Polska) celebrate their award of traditional Swiss cowbells for being the winning team of the Annual BBR Charity Golf Tournament.





# WONDERS OF THE BBR WORLD

The Seven Wonders of the Ancient World are well-known – almost legendary – structures at which people in antiquity marveled. All of them were of a size and complexity that challenged belief. They largely consisted of structures within the Eastern Mediterranean – the ‘known world’ to the pre-jet age list makers and range from the Hanging Gardens of Babylon to the Great Pyramid of Giza. Now, to celebrate BBR’s 70th Anniversary, we have compiled our own list of Wonders of the BBR World.

Looking at our built environment today, we can clearly see how the BBR family has 'touched the world' on every continent, often working closely with acclaimed architects and engineers – such as Sir Norman Foster, Santiago Calatrava, Leonhardt Andrä & Partner, Christian Menn and Zaha Hadid.

1957

**Plaza de Toros, Canavaralejo, Columbia**

The 16,954-seater grandstand at the Plaza de Toros in Canavaralejo was declared a National Monument, in 1995, by the Columbian Ministry of Education. Designed by Guillermo Gonzalez Zuleta, it was constructed to a design resembling a martini glass. The cantilevering grandstands are built of post-tensioned concrete. Each ring is made up of four BBR tendons with a fixed anchor on one side. On the other side, the cable is split and has two movable anchorages. The anchorages are staggered within eight ribs.





## 1972

### **Olympic Stadium, Munich, Germany**

The roof of the stadium built in Munich for the 1972 Olympic Games saw the first large scale application of the then newly-developed BBR High Amplitude (HiAm) parallel strand stay cable system. The structure has now been a landmark on the Bavarian skyline for over 40 years. The design challenge was to create a 75,000m<sup>2</sup> roof which featured large column-free spaces. Skillful management of the prestressing forces achieved a perfect adaptation of the shape of the Olympic roof to the architects' requirements and the site conditions.

## 1981

### **Sydney Tower, Sydney, Australia**

Originally constructed as the defining architectural feature of the Centerpoint retail and commercial development, this 309m high tower remains Sydney's tallest structure. The shaft of the tower is stayed by a system of BBR parallel wire prestressing cables. The 56 stay cables are formed into a hyperboloid of revolution in two groups, each of 28 straight cables. The cables are anchored to the roof of the building in a 37.2m diameter circle. After over three decades, the stay cables are still meeting anticipated performance criteria. ➤





## 1985

### **King Fahd Causeway, Bahrain-Saudi Arabia**

In carrying out post-tensioning work for this structure, BBR technology was not only applied to one of the world's largest bridge projects, but was also subjected to impressively stringent conditions in terms of durability. Some 25,000m of post-tensioning was installed during the contract. Particular attention was paid to the depth of concrete cover applied to the reinforcement and post-tensioning – depending whether the exposed zones were completely underwater, exposed to tidal and splash or in a wet or dry atmosphere.

Photograph © Mohamed Ghuloom / Wikimedia Commons / CC-BY-SA-3.0



## 1997

### **Godavari Railway Bridge, India**

The third Godavari Railway Bridge is 2,731m long and has 28 identical spans of 97.55m. The simply supported bowstring girders consist of a slender twin concrete arch, tied at the bottom by a stiff centrally prestressed box girder which is continuously suspended to the arch by twelve pairs of hanger cables. The twin concrete arches were erected by the balanced suspended cantilever construction method using temporary stay cables which were fixed to a temporary steel tower erected on top of the pier.

# 1999

## Tatara Bridge, Japan

The westernmost route of the Honshu-Shikoku Expressway includes the 1480m long steel-concrete hybrid cable-stayed Tatara Bridge. Its 890m main span was the longest in the world when it opened. The BBR stay cables were installed in a two-plane multi-fan configuration. The longest stay cables are 460m long with a diameter of 170mm. The stay cables are protected by a black HDPE jacket filled with a corrosion protection compound, while the outer surface is dimpled to repel rainwater and break up gusts of wind.

Photograph © Mukarin / Wikimedia Commons / CC-BY-SA-2.0



# 2008

## Arena Zagreb, Croatia

The simple, elegant and efficient structural concept of the Zagreb Arena was recognized at the World Architecture Festival in Barcelona in 2009 where it was declared the outright winner in the structural design category. Each of the 86 large curved concrete columns – ‘lamellas’ – forming the main façade and supporting the roof structure and the semi-translucent building envelope were prestressed using the BBR VT CONA CMI system – requiring 214t of strand, together with 680 anchorages. It took just six months to prefabricate, lift and fix the lamellas onto the structure. ●

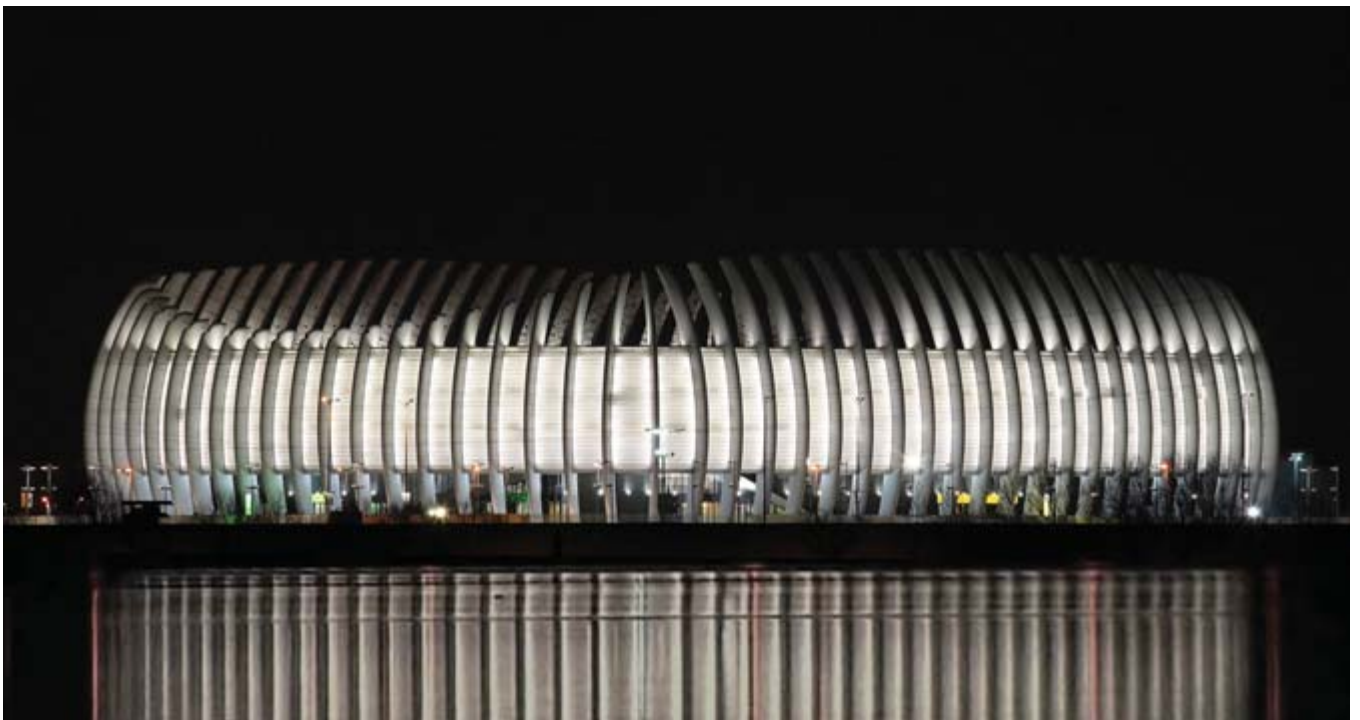





1

## 70 YEARS OF INNOVATION

BBR – the early years

# NURTURING INNOVATION

The BBR story began in 1944, when three graduates of the Swiss Federal Institute of Technology (ETH) formed a partnership to promote innovative construction components and techniques. Max Birkenmaier, Antonio Brandestini and Mirko Robin Roš, the founders of BBR, were key players on the construction engineering scene when the challenges and opportunities had never been greater.

With economies at that time in the grip of the Second World War, this was a period of immense shortages – energy needed for cement production was in short supply and there were obvious difficulties involved in importing steel. When Birkenmaier, Brandestini and Roš became aware of the ideas of French engineer Eugène Freyssinet – which had been published in the French journal 'Travaux' – they recognized the potential.

The trio first met during their time at ETH in the late 1930s, however, by the time they decided to form their partnership, Max and Antonio were working at Swissboring SA, a specialist geotechnics firm, and Mirko as a research associate at EMPA, the Swiss Federal Laboratories for Materials Testing

& Research – where he was compiling information associated with prestressing and starting research for further development. In an interview for CONNÆCT 2010, Frau Birkenmaier described her late husband Max as "very much an engineer and technically brilliant – although he was a rather academic, conservative type, while Antonio was more of an outgoing entrepreneurial character, a businessman." In the early days of the business, she supported the three engineers as a clerk in their offices near Zurich's Limmatquai and Max used to take his son, Max junior, on construction site visits. During his career, he was heavily involved in norm committees and received a honorary doctorate from ETH for his achievements.

1 Max Birkenmaier, Antonio Brandestini and Mirko Robin Roš, BBR's three founders.

2 Main building of the ETH in Zurich where the three BBR founders studied. Source: ETH Zurich / Esther Ramseier.

**Extract from Patent Specification  
No 694596, for the new BBRV  
cold-formed button headed  
anchorage, made to The Patent  
Office, London, March 9, 1951:**

"The invention relates to an improved method of, and means for post-tensioning and anchoring reinforcements in concrete structures (e.g. walls or bridges cast in situ) or structural concrete elements (e.g. beams) the reinforcements consisting of steel wires of high tensile strength whose ends are held against release by anchor members."

**Manufacturing base**

Giovanni Rodio, who headed up Swissboring, encouraged their interest in prestressing and, in 1945, supported the three engineers in the financing and setting up of a manufacturing facility in Frick – now Stahlton AG – to produce their inventions. Since the initial BBR partnership was formed, the team has filed over 100 patents for inventions. The first of these submissions, number 265434 – made in Switzerland on 25th July 1946 and granted in December 1949 – was for what became known as the 'Stahltonbrett' – a prestressed concrete beam or lintel. Roš's daughter, Cornelia Bodmer-Roš, explains: "The Stahltonbrett is made of clay – and the reason they came to Frick was that it needed a very special clay that doesn't hold too much water. After searching all over Switzerland, they met Mr Keller who still has one of the largest brick manufacturing companies – and they built their factory next door."

**Safe anchorage**

In Europe, as well as in Switzerland, there was demand for prestressing concrete with anchored tendons – the so-called post-tensioning method. While anchorages for prestressing steel existed, their accuracy was inadequate, as the wedges did not work properly.

The BBR partners opened discussions with well-known wire producer, Dipl. Ing. Karl Vogt and together they developed the cold-formed button headed anchorage, bringing it to market under the 'BBRV' brand. The patent was applied for in 1950 in Switzerland and subsequently in other European countries, including the UK. As well as the three BBR founders, other eminent engineers took an active role in spreading the word about the new Swiss BBR technology. For example, in May 1965, Hans Rudolf Müller – while working with Roš at Stahlton – gave a presentation about BBRV anchorages used in various types of soil at the Swiss Society for Soil Mechanics and Foundation Technology Conference in Zurich in which he explained, in a particularly clear fashion, the definition of prestressing:

"Prestressing is understood to mean the application of a state of stress to a structure or structural element (in this case a foundation anchor) in such a way that the tensioning force always acts to compensate the live loads. The prestressing force must always be greater than the force exerted by the live load to be compensated."

While Mirko Robin Roš continued to lead his own consulting engineering practice and Max Birkenmaier was running the Stahlton business, in 1954, Antonio Brandestini founded Proceq – to produce PT equipment and further equipment for the construction industry.

News of the Swiss BBR inventions travelled around the world and international demand for the new technology quickly grew.

Initially, this trade was developed through licensing arrangements and, more recently, through franchising agreements – and the creation of the BBR Network.

As the next pages show, in seven decades, the BBR team has never tired of going the extra mile to invent technology suited to market needs, nor of implementing their technology on some of the world's most challenging projects. ●





# JOURNEY THROUGH TIME

Sustained focus by BBR engineers on customer needs has delivered many world class solutions – and some of the finest Swiss-engineered construction technology and techniques. The small selection of projects and events, presented here chronologically, show how BBR technology and expertise has developed over seven decades.



**1944**  
BBR Partnership formed

**1946**  
Development of the 'Stahltonbrett', the first post-tensioned small beam

**1953**  
First use of BBRV ground anchors – Maggia Power Station Control Room, Verbano, Switzerland

**1960**  
BBR wire stay cable system first implemented on the Schillersteg pedestrian footbridge, Stuttgart, Germany

**1964**  
**Lafontaine Tunnel, Montreal – Canada's largest underwater tunnel ★**

**1968**  
Development of BBR parallel strand stay cables

**1970**  
Development of BBR HiAm (high amplitude) fatigue resistant wire stay cable system



**1971**  
**World's first bridge with parallel steel wire bundles – Kurt Schumacher Bridge, Mannheim, Germany ★**

**1975**  
Development of BBR DINA stay cable anchorages



**1947**  
Development of BBRV cold formed button headed post-tensioning system begins

**1957**  
Félix Houphouët-Boigny Bridge, Abidjan, Ivory Coast – PT box girder road & rail bridge

**1965**  
Full-scale facility was constructed for testing BBR nuclear tendons – some 65 nuclear projects have been carried out worldwide

**1967**  
Johanniter Bridge, Basel – first large bridge constructed in Switzerland using free cantilever method

**1978**  
**World's first cable net supported tower – Sydney Tower, Australia ★**

**1952**  
Start of first major bridge project using BBR technology and application of 1,250kN capacity tendons – the Weinland Bridge at Andelfingen, Switzerland

**1958**  
Development of BBR fatigue resistant wire stay cables

**1972**

- Construction of roof for Olympic Stadium, Munich, Germany with BBR HiAm strand stay cables (pictured left)
- Centrale Nucleaire Bugey, France
- Development of BBR CONA strand PT system
- Formation of limited company – Bureau BBR Limited

**1972-7**  
**World's first long span cable-stayed railway bridge – Zarate Largo Bridges, Argentina ★**



**1981 & 2005**  
World's first cable-stayed bridge to be built twice – and world's largest cable-stayed bridge reconstruction project, Sloboda Bridge, Novi Sad, Serbia



**2000**  
Seri Saujana Bridge, Putrajaya, Malaysia



**1996**  
World's first bridge to use carbon stay cable technology – Storchenbrücke, Switzerland ★



**1987**  
World's longest transit skytrain-only bridge – ALRT Skybridge, Canada ★

**1988**  
• Units 1 & 2, Bellefonte Nuclear Plant, Alabama, USA  
• Chandonline Bridge, Sion, Switzerland



**2005**  
World's largest LNG tank – Darwin, Australia ★

**2011**  
Launch of BBR HiEx CONA Saddle



**2013**  
Opening of Hardanger Bridge, Norway constructed using BBR rock anchors

**2006**  
Launch of all-new post-tensioning range – BBR VT CONA CMX

1980 1990 2000 2010 2020



**1985**  
• World's largest bridge project – Saudi Arabia-Bahrain Causeway (pictured above) ★  
• Diepoldsau Bridge, St Gallen, Switzerland  
• Farø-Falster Bridge, Denmark  
• Dungeness B-2, Nuclear Power Station, Kent, England

**1997**

- Longest cable-stayed bridge built in 20th Century – Tatara Bridge, Japan (pictured below: Photograph © Simcat / Wikimedia Commons / CC-BY-SA-3.0) ★
- Completion of Godavari Bridge, the longest railway bridge in India
- Opening of Sky Tower, Auckland, New Zealand – tallest tower in southern hemisphere



**2014**



**2012**  
Europe's largest single pylon cable-stayed bridge – Sava Bridge, Serbia ★



**1993**  
• Croatia's first substantial motorway reinforced concrete arch bridge – Maslenica Bridge (pictured above)  
• Company name changed to BBR Holding Ltd  
• Tahtiniemi Bridge, Finland

**1994**

- Longest cable-stayed bridge in Asia opens – Second Hooghly River Bridge, Calcutta, India ★
- Development of BBR Carbon Stay Cables



**2008**  
World's first floating LNG tank – Isola di Porto Levante, Italy ★



**2009**  
South Hook LNG tanks, Wales, UK



# CENTERPIECES AND MASTERPIECES

The award-winning Sunniberg Bridge – near the Swiss alpine ski resort of Klosters – represents the culmination of years of technological development at BBR, combined with the skills and inspiration of leading Swiss designer Christian Menn. When the project – featuring DINA stay cables – was completed in 1998, it was acknowledged as a great example of aesthetic design, structural form, quality and cost.

The five-span, cable-stayed Sunniberg Bridge is 526m long and stands 60m above a river valley. It has a 503m radius curve and tall, slender piers extending to short above deck pylons, which incline outwards. It was constructed using the balanced cantilever method with form travelers and deck sections of four meters. As well as providing and installing 148 DINA stay cables, the construction team also installed seven tons of BBR CONA post-tensioning tendons and a further 30 tons of BBRV tendons for the cross girders. The project was awarded IABSE's 2001 Outstanding Structure Award.

In the last 70 years, the BBR Network has produced a staggering total of over 400 cable-stayed projects – and the majority of these have been bridges. Pioneering BBR technology enabled construction teams to be the first to use wire stay cables (1958), first to use strand stay cables (1968) and first to use carbon stay cables (1994). Here, we take a trip down Memory Lane and explore some of the stay cable bridge projects in the BBR archive.

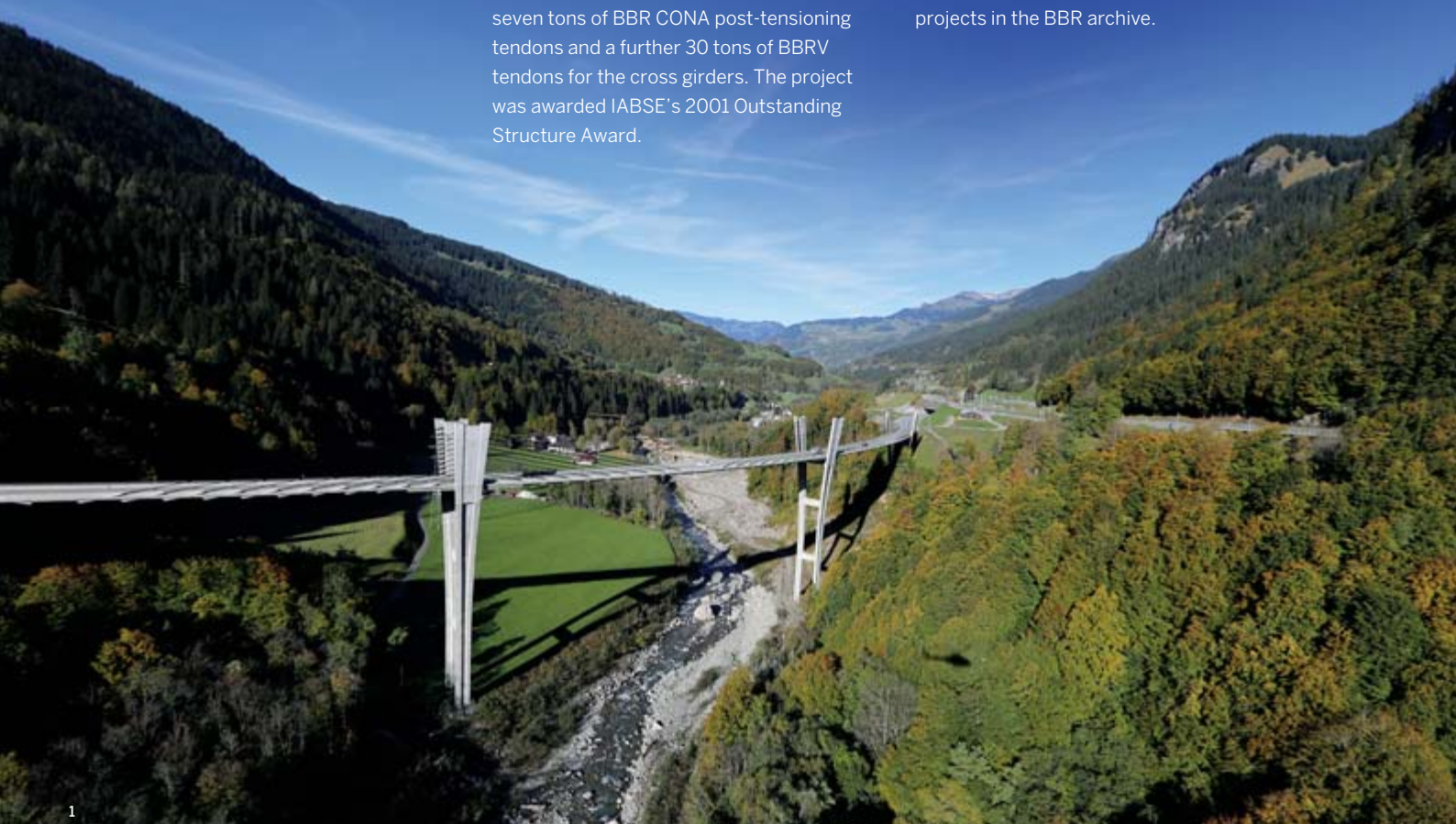



2

### First wire stay cables

BBR developed the wire stay cable system which was first implemented on a pedestrian bridge in Stuttgart, designed by the leading engineering practice, Leonhardt Andrä & Partner (LAP). Back in 1957, the city was making plans to stage the 1961 Bundesgartenschau – national garden show. It was a tight schedule, with two years for construction and barely a further two years remaining for the planting to be carried out and become established.

As with every garden show, architectural innovation was also brought to this event – in the form of a pedestrian-friendly footbridge to connect the upper and middle castle gardens which were separated by a busy highway. BBR's parallel wire stay cable system was used for the first time on this 100m long bridge. From the top of the 23m high octagonal hollow steel pylon, there are three pairs of stay cables to the 63.5m long main span of the bridge deck and a further two pairs to the northern part of the bridge. The stay cables are protected by PE ducting and cement grout.

Still fully functional and serving its original purpose over 50 years later, this small cable-stayed bridge – originally called Schillersteg after the main road beneath, but now known as Ferdinand-Leitner-Steg – was to open the door to further developments in stay cable technology, as well as to many more projects.



3

After the success of their first cable-stayed bridge project in Stuttgart and establishing a good working relationship, BBR and LAP continued to work together to develop the technology further. In the 1960s, stay cables were mostly made of locked coil ropes, but BBR and the LAP team wanted to achieve a greater stiffness and fatigue strength by using parallel wire cables. The result of this technological collaboration was the development of the BBR HiAm (high amplitude) wire stay cable system. The new BBR HiAm stay cable system was first applied in 1971 – to the 433m span of the Kurt Schumacher Bridge over the River Rhine at Mannheim-Ludwigshafen. The bridge features 36 BBR HiAm stay cables and now carries both traffic and trams across the river.

The DINA stay cable system was developed and launched in 1975 – while BBR expertise literally travelled around the world, with projects on every continent. ►

- 1 Sunniberg Bridge, Klosters, Switzerland.
- 2 Schillersteg Bridge, Stuttgart, Germany – built in the late 1950s, the first cable-stayed bridge constructed with BBR technology is still fully functional today.
- 3 Kurt Schumacher Bridge, Mannheim-Ludwigshafen, Germany – the BBR HiAm stay cable system was first applied in 1971 to the 433m span of this bridge.





4

**On every continent**

Construction of two almost identical 550m long cable-stayed road and railway bridges near Buenos Aires, Argentina – the Zarate-Brazo Largo Bridges I & II – began in 1972. When they opened in 1977, they were the world’s first cable-stayed bridges to carry a full railway load.

In North America, the design for the new 763m long Pasco-Kennewick Bridge – now officially called the Ed Hendler Bridge – was ground-breaking. This was to be a precast, prestressed concrete structure, rather than fabricated steel, and would have a cable-supported girder length of 547m. The bridge has two approach spans and a three span cable-stayed section. Opened in 1978, this was the longest cable-stayed bridge on the continent.

Also during this decade, the River Sava Railroad Bridge in Belgrade was one of many projects underway in Europe. It was to be the first cable-stayed bridge built solely for railway traffic. Just as the first train rolled across Belgrade’s new bridge in 1979, so another major scheme began in another part of the world. This time, it was in India – and involved the construction of a major crossing of the Hooghly River, known as the Second Hooghly Bridge – now the Vidyasagar Setu Bridge. This was the first cable-stayed bridge in the country and today, it remains the longest cable-stayed bridge in India.



5



6

## BBR STAY CABLE DEVELOPMENTS

1958	Development of BBR fatigue resistant wire stay cables
1970	Development of BBR HiAm (high amplitude) wire stay cable system*
1975	Development of DINA wire stay cable system
1992	BBR CONA STAY cable system
1994	Development of BBR Carbon stay cable system
1996	First application of BBR Carbon Stay Cables
2008	Introduction of BBR HiAm CONA strand stay cable system
2011	BBR HiEx CONA Saddle launched
*in association with Leonhardt, Andrä & Partner, Stuttgart.	

### Energetic '80s

By the middle of the 1980s, several major bridges had been completed in Japan with BBR stay cable technology, as the nation continued with its major highway construction program.

At Port Nagoya, the 758m long Meiko Nishi Bridge – with its distinctive red pylons and its 96 BBR HiAm stay cables – was opened in 1985 as part of the Isewangan Expressway. Eleven years later, its twin – the Second Meiko Nishi Bridge, was inaugurated. Next came the Iwakurojima Bridge and Hitsuishijima Bridge for the Honshu-Shikoku Expressway project. Both bridges have total spans of 790m and each has 176 BBR HiAm stay cables.

One of the largest cable-stayed bridges to be built in Europe in the 1980s was the Farø-Falster Bridge in Denmark. The 1,726m long bridge stands over the channel separating Farø and Falster islands. Two 95m high A-shaped pylons provide the upper anchorage for the 36 BBR HiAm stay cables. As the decade drew to a close, an ambitious project was also nearing completion in Vancouver, Canada. When it opened in March 1990, the 616m long Skybridge spanning the Fraser River became the world's longest transit-only cable-stayed bridge carrying three railway tracks. It has two 123m pylons at the top of which the 124 BBR HiAm stay cables supporting the 340m main span are anchored. ▶

- 4 Ed Hendlar Bridge, Washington State, USA – with its 144 BBR HiAm parallel stay cables, arranged in a fan shape over two planes.
- 5 Vidyasagar Setu Bridge, India – a composite box girder bridge with three spans, featuring 148 BBR HiAm stay cables arranged in a double plane around the two pylons.
- 6 Hitsuishijima Bridge (far) and Iwakurojima Bridge (near), Japan – now carry four lanes of highway traffic on the upper deck and two railway tracks on the lower deck. Photograph © Sam / Wikimedia Commons / CC-BY-SA-3.0
- 7 Farø-Falster Bridge, Denmark – constructed between 1980-85, this was one of the largest cable-stayed bridges built in Europe during that decade.



7





8

### Creating new records

At the start of the 1990s, BBR Network Members found themselves working in very chilly conditions – in north western Norway, just below the Arctic Circle – on the Helgeland Bridge. The 1,065m bridge has 12 spans – the longest of which is 425m. The 128 BBR HiAm stay cables are protected by PE pipes – however, as temperatures were too low to further protect them against corrosion by using a cementitious grout on site, they were injected with petroleum wax during shop fabrication.

The opening to traffic of Japan's latest highway bridge in December 1991 would, in hindsight, appear to have been prophetic – some of the techniques used in its construction were later used in building the great Tataru Bridge. The Ikuchi Bridge, part of the Nishi-Seto Expressway, was the longest cable-stayed bridge in the world when completed. It is a composite box girder cable stayed bridge with three continuous spans covering 790m and supported by 56 BBR HiAm stay cables.

BBR Carbon stay cables were developed in 1994 and the first application was in April 1996, on the twin-span Storchenbrücke cable stay bridge in Winterthur, Switzerland. Two BBR Carbon Stay cables were installed alongside traditional BBR DINA parallel wire cables in. Monitoring shows excellent results. An interesting phenomenon has been observed between the two stay systems – unlike in steel tendons, the thermal expansion of CFRP stays is almost zero. Therefore, a seasonal variation of the cable force can clearly be observed. Finland's stunning Raippaluoto Bridge was inaugurated in August 1997. The 1,045m long bridge has two A-shaped concrete pylons and features 64 BBR HiAm stay cables. The concept of using prefabricated cables, during the cold winter months, yet again, proved to be a wise choice.



9

In 1999, the magnificent Tataru Bridge in Japan was opened and immediately took the record for being the longest cable-stayed bridge constructed in the 20th century – see page 35.

In the 1990s alone, the team installed nearly 7,000 stay cables across 180 projects ranging from bridges and stadiums to railway stations and swimming pools. At the end of the decade, many stay cable bridge projects were in progress – including the ground breaking Sunniberg Bridge – ensuring that the new millennium would be welcomed in by some of the finest civil engineering structures on the planet.

### Exceeding own benchmarks

As anticipated, the year 2000 was exceptional – with official openings for a number of the BBR Network’s major stay cable bridge projects.

In the heart of Warsaw, the new 479m long Swietokrzyski Bridge over the River Vistula was opened in October 2000 after a two year construction period. It has a single 90m high pylon and its 180m main span is supported by 48 BBR HiAm stay cables. Back in Japan, the twin Ibigawa and Kisogawa Bridges – known collectively as the ‘Twinkle Bridges’ – were entered into service, each carrying six lanes of traffic, as part of the New Meishin Expressway. They have, respectively, 228 and 192 BBR HiAm stay cables arranged around five and four 30m pylons – and anchored in the centre of the highway.

Another example of a structure serving highway infrastructure is the RAMA VIII Bridge in Thailand. Wedge-anchored BBR HiAm strand stay cables have been used in this bridge, which is one of many large bridges that span the Chao Phraya River in Bangkok.

Opened in 2003, the Seri Saujana Bridge in the Putrajaya district of Kuala Lumpur, Malaysia is the world’s first cable-stayed arch bridge spanning across an artificial lake. It is a unique structure because the deck is supported by a hybrid system of arch and stay cables. The 42m high pylon forms the upper anchorage point for the 84 BBR CONA STAY cables.



10

### Bridge built twice

Perhaps the most bizarre – and equally poignant – record ever set by the BBR Network so far has been for their work on the 1,312m long Sloboda Bridge over the River Danube at Novi Sad in Serbia. When completed – with its 48 BBR HiAm stay cables – in 1981, it was one of the largest single plane stay cable bridges. Today, it holds the distinction of being the only stay cable bridge in the world to have been built twice. After NATO air strikes in April 1999, the original bridge was destroyed. It was reconstructed to the same design and opened in 2005 and this time featured BBR CONA STAY cables – chosen for their excellent flexibility in terms of last minute on site adjustability, which makes it the ideal stay cable system for a reconstruction project.



11

- 8 Ikuchi Bridge, Japan – it is a composite box girder cable stayed bridge with three continuous spans covering 790m and supported by 56 BBR HiAm stay cables. Photograph © Tomomarusan / Wikimedia Commons / CC-BY-SA-3.0
- 9 Helgeland Bridge, Norway – the 128 BBR HiAm stay cables were protected from corrosion by PE pipes injected with petroleum wax, as temperatures were too low for cementitious grout to be used.
- 10 Swietokrzyski Bridge, Warsaw, Poland – the new 479m long bridge over the River Vistula has a single 90m high pylon and its 180m main span is supported by 48 BBR HiAm stay cables.
- 11 Sloboda Bridge, Novi Sad, Serbia – the world’s only stay cable bridge to have been built twice, in 1981 and 2005.





12

**Continuing acclaim**

In 2006, the Eleanor Schonell Bridge – or Green Bridge – opened. It is Australia’s first bridge exclusively designed for buses, cyclists and pedestrians and the nation’s second longest cable-stayed bridge. The Assut de l’Or Bridge’s distinctive 125m tall pylon is the highest point in Valencia’s City of Arts and Sciences, in eastern Spain. Designed by leading architect, Santiago Calatrava, this 292m long cable-stayed bridge has 29 front BBR HiAm CONA stay cables arranged in a harp style, with a further four rear stay cables in white HDPE pipes anchored in pairs at right angles to the ground. The bridge was opened to traffic on 22 August 2008, for the Formula 1 Grand Prix weekend in Valencia. BBR world records also continued into the second decade of the new millennium, with the most recent being the opening in 2012 of Serbia’s Ada Bridge over the River Sava in Belgrade – the world’s longest single pylon stay cable bridge. Installation of the 80 BBR HiAm stay cables was achieved to timescales which might also be a record. When the project completion date was brought forward, the BBR Network Member revised their strand installation procedures, thereby saving six months on the original 18 month program.



13

In June 2013, the longest bridge over the River Danube was inaugurated. The 779m main section of the Danube Bridge 2 – officially now the **New Europe Bridge** – has five spans, all of which are sustained by stay cables. As well as some 2,100t of BBR VT CONA CMI tendons, the BBR Network also installed 208 BBR HiAm CONA stay cables – and the first BBR HiEx CONA Bundle Saddles.



14

Shortly afterwards, the latter were used again for Portugal's Rio Corgo Viaduct which opened just a few months later, in September 2013. The Corgo Viaduct is the most striking structure of the Auto-Estrada Transmontana – the nearly 140km long motorway which connects the cities of Vila Real and Bragança – a step further along the way to completing the great northern highway of Portugal, linking Oporto to the Spanish border. The central stayed viaduct consists of seven spans – the use of stays was essential because of the difficulty in placing pillars on the sheer banks of the river and the sloping terrain. The 63m high pylons tower above the 130m high bridge pillars, while the valley floor lies 70m further below the pillar foundations. By the end of the project, 88 stay cables – 22 pairs per pylon – had been installed and the longest cable was 159m. BBR HiAm CONA anchorages, ranging between 42 and 69 strands, were used.

These few projects, presented here to illustrate the story of BBR's extensive track record, are just a small insight into the long, exciting and successful BBR journey in the development of stay cable technology. For more information, please download our Stay Cable Reference List from the BBR website. ●



15

- 12 Eleanor Schonell 'Green' Bridge, Brisbane, Australia – Australia's first bridge designed exclusively for buses, cyclists and pedestrians.
- 13 Assut de l'Or Bridge, Valencia, Spain – designed by Santiago Calatrava, this 292m long cable-stayed bridge has 29 front BBR HiAm CONA stay cables arranged in a harp configuration, with four rear stay cables.
- 14 Ada Bridge, Serbia – the world's longest single pylon stay cable bridge.
- 15 Rio Corgo Viaduct, Portugal – part of a major northern highway, the bridge has 88 stay cables, 22 pairs for each of its pylons. The longest stay cable was 159m.



Creating longer, stronger spans

# BRIDGING PAST, PRESENT AND FUTURE

Poland's longest bridge – nearly two kilometers long – spans the River Vistula near Grudziadz and won the Masterpiece of Bridgebuilding Award in 2011, presented by the Bridge Builders Association of Poland. The bridge was constructed with the very latest technology and multi-disciplinary know-how from the BBR Network – and carries forward, to future generations, the spirit and ingenuity of the BBR founding fathers and those who worked closely with them.

A vital part of the new stretch of the A1 motorway, Grudziadz Bridge consists of a 43-section, 988.8m long longitudinally launched overpass, a three span cantilever main bridge featuring a 180m concrete span a 556.8m long and an incrementally launched overpass with 25 sections, each 24m long.

The BBR Network contributed to the design of the cantilever section, supplied and serviced formwork travelers, internal and external stressing technology and modular expansion joints. Despite harsh winters, unexpected floods – and a tight schedule – the project was completed on time.



“The technical significance of this new bridge can only be fully appreciated when, as well as its exterior appearance, its ‘interior’ features are also understood.”

Prof. Dr. P. Lardy, ETH, Zürich in ‘Die technische Bedeutung der Weinlandbrücke’

### Early experiences

Turning the clock back to the 1950s, the BBR system was being applied for the first time on a long span bridge project – of very much more modest dimensions. Constructed between 1955 and 1958, the 293m long cast in-situ box girder Weinland Bridge at Andelfingen was to deliver a great deal of experience and information. It was built by the span-by-span method on falsework – and on a 3.5% gradient. Both horizontal and transverse BBR post-tensioning tendons were used in the 3.9m deep concrete bridge deck. It was the first ever application of 1,250kN capacity tendons.

These were still pioneering days for post-tensioning and much testing and measuring was carried out on the tendons themselves and on the behavior of the bridge during various stages of construction.

The information gathered during this project was the subject of a comprehensive 28-page technical briefing paper. It was acknowledged that the willingness of the Government of the Canton of Zurich to embrace a post-tensioned approach to this bridge had created a valuable addition to technical and scientific knowledge.

During the same period, the Félix Houphouët-Boigny Bridge, in Abidjan, Ivory Coast – designed by Nicolas Esquillan of Boussiron – was under construction. The prestressed precast pier caissons and six meter long piles were tied together by 28 individual 8mm diameter wires secured with BBRV button headed anchors. The hollow precast girders for the superstructure – containing 404 BBR post-tensioning tendons, using a total of 16,300t of prestressing steel – were floated into position after prestressing and lifted onto the piers.

### Tales from the Vienna Woods

In the early 1960s, a young engineer by the name of Wilhelm Zellner was working on the Brenntenmais A1 Motorway Bridge across a valley, near to the Vienna Woods. He recalls that this was the first occasion that BBRV post-tensioning was used in any great quantity in Austria.

At that time, the BBRV post-tensioning system particularly impressed him for two reasons. Firstly, slippage at the anchorage

– after an initial eliminable slip – was practically zero. Secondly, very high prestressing forces of up to 150t per single tendon were possible – at that time in Germany, stresses of only up to 108t were achievable. His ability to confirm that the friction coefficient was 0.15 delighted his employer and their client – and ultimately led to his long association and prolific career with Messrs Leonhardt and André.

### Swiss records

The new 1,126m long railway bridge – Zurich’s Hardturm Viaduct – is the longest railway bridge in Switzerland – and, when completed in 1969, it was the longest post-tensioned concrete railway bridge in Europe. The box girder superstructure is longitudinally post-tensioned with BBRV tendons – the relatively small spans meant that transversal post-tensioning was unnecessary. A major feature of the route is the 8,024t twin-track Limmatfeld Bridge in which the gross tensile force was described, at the time, as equalling the weight of around 68 heavy Swiss Railway locomotives. ▶



2



3



4



5

- 1 Grudziadz Bridge, Poland – consists of a longitudinally launched overpass, a three span cantilever main bridge and an incrementally launched overpass.
- 2 Static load testing of the Weinlandbrücke at Andelfingen took place on 15th November 1957, with 24 trucks weighing a total of 312t. The 88m long span behaved exactly as expected – it was a perfect result.
- 3 Félix Houphouët-Boigny Bridge, Abidjan, Ivory Coast – BBR technology was used for the tying together of the prestressed precast pier caissons and six meter long piles and also for the hollow precast girders of the superstructure which were floated and lifted into position.
- 4 Brenntenmais A1 Motorway Bridge – this project was the first to use BBRV post-tensioning in any great quantity in Austria.
- 5 Hardturm Viaduct, Zurich, Switzerland – when completed in 1969, it was the longest post-tensioned concrete railway bridge in Europe.





6



7

**Developing new techniques**

Meanwhile, in the Swiss capital city, Basel, construction of the Johanniter Bridge was underway. This was the first occasion on which free cantilever reinforced concrete construction had been used for a large bridge in Switzerland. Around 480t of prestressing steel, some 40,000m of ducting and 750 BBRV anchorages were used. Averagely, the site team was able to construct six or seven – of a total of 244 – segments each week – equating to around 218-255m<sup>2</sup> of bridge deck.

**Twinning bridges**

The Deutz Bridge over the River Rhein in Germany was opened in 1948 and was of steel box girder construction, carrying four lanes of traffic. The widening of the bridge was achieved by building a parallel three-span concrete structure which is connected to the steel bridge. The new bridge, opened in 1980, with its 60m center span features BBR post-tensioning – and was another opportunity to work collaboratively with LAP. When, in 1982, Perth’s Mount Henry Bridge opened to traffic, it became the longest road bridge in Western Australia. The nine span structure features BBR post-tensioning and was constructed segmentally, using the balanced cantilever method. This bridge was also twinned over 20 years later, to accommodate a railway line – and, again, BBR technology and expertise in post-tensioning and incremental launching systems met the challenges. Building a twin bridge was also the chosen solution when the 1958-built steel-framed Burlington Bay Skyway Bridge in Ontario, Canada, could no longer cope with modern traffic flows. So, in the early 1980s, construction of the new 2,200m long balanced cantilever bridge began alongside.

Opened in 1985, the new twin bridge, with its new name – the Burlington Bay James N. Allan Skyway – now carries eight lanes of traffic and links Fort Erie with Toronto. The following year, 1986, the King Fahd Causeway – Saudi Arabia-Bahrain Causeway – was officially opened. It remains the world’s largest bridge project and further details can be found on page 34.

**Pushing back frontiers**

In 1994, even as the team at BBR celebrated their 50th Anniversary, they were still pushing at the frontiers of construction technology. They were working on Croatia’s first reinforced concrete arch motorway bridge with a substantial span. The 380m long Maslenica Bridge – an open spandrel arch bridge completed in 1996 – was constructed step-by-step from both banks by the suspended cantilevering method. This method had also been used in the early 1980s for construction of South Africa’s Bloukrans Bridge – a much more economical solution than constructing scaffolding formwork, the method used in the early days. A few years later, BBR – in joint venture with EMPA – achieved another first application when, in 1998, the Kleine Emme Bridge, near Lucerne, Switzerland became the first bridge to have external CFRP post-tensioning tendons. Although for pedestrians and bicycles, the composite 47m long bridge was designed to take the maximum load needed by emergency vehicles. Two CFRP tendons were produced and consisted of 91 x 5mm diameter CFRP wires with a breaking load of 4,000kN. The two tendons were transported to site on reels and installed and tensioned in the bottom chord of the new bridge.



8

- 6 Deutz Bridge, Cologne, Germany – bridge widening was achieved by building and attaching a parallel three-span concrete structure, the 60m center span features BBR post-tensioning.
- 7 Maslenica Bridge, Croatia – the country’s first reinforced concrete arch bridge was constructed using the suspended cantilevering method.
- 8 Mount Henry Bridge, Perth, Australia – twinning of the original bridge, both built with BBR technology.
- 9 Kulmbachtal Bridge – completed superstructure to the west and assembly of the first section of the eastern superstructure underway.
- 10 Waipuna Bridge, Auckland, New Zealand – the 54m long precast prestressed cantilever road bridge was strengthened using the latest BBR technology, the BBR VT CONA CMB band system.
- 11 Bangkok Industrial Ring Road, Thailand – the BBR Network installed post-tensioning and carried out design, fabrication and operated the movable scaffolding formwork for the approach structure leading to the main river crossing and also the interchange area.



9



10



11

### Working with new technology

Following the launch of BBR's ETA-compliant all-new range of post-tensioning technology in 2006, the first application of BBR VT CONA CMI internal tendons worldwide was celebrated on the Kulmbachtal Bridge in Germany. This was the largest of nine bridges on the A6 motorway widening project and consists of a single prestressed concrete box girder bridge with nine spans to be constructed by incremental launching. It was vital that the post-tensioning system chosen should have as small as possible center spacings and edge distances from the tendon anchorages, as the existing carriageway slab was just 48m thick and there were a large number of tendons. In addition, the minimum concrete strength at the time of stressing had to be as low as possible to achieve the weekly construction cycle.

Once again, the BBR engineers had developed and produced exactly the right technology to meet the needs of the ever-changing market place at exactly the right time.

By 2008, BBR engineers could have been forgiven for thinking that there could be no greater challenge than they had already faced – and then Bangkok's Industrial Ring Road project came along. Their task included installing post-tensioning and the design, fabrication and operation of the movable scaffolding formwork.

In a sense, the BBR bridge engineering story comes full circle with the 2012 Waipuna Bridge project in New Zealand. The latest BBR technology – the BBR VT CONA CMB band system – was eminently well-suited to strengthening the 37-year old 54m long precast prestressed cantilever road bridge near Auckland. The team also future-proofed the structure by making provision within the new end anchorages for a further 12 CONA CMB band tendons to be installed, should the bridge be widened to carry more lanes of traffic.

The constantly developing and evolving BBR insight, technology and expertise continues to be relevant for many bridge projects – for new build, widening and renovation – throughout the world. ●





1



2



3

## BUILDINGS

Realizing aspirational structures with BBR technology

# ARCHITECTURAL FREEDOM

With the development of BBR post-tensioning technology, architects the world over have been able to give full reign to their creativity – designing structures previously impossible to achieve. They sought many new devices – height, dramatic building forms and column-free spaces – with which to enthrall and delight their audiences.

The three BBR founders each worked hard to communicate the benefits of their technology and, in 1961, Antonio Brandestini wrote an article for the Swiss trade magazine, *Schweizerische Bauzeitung*, in which he outlined the processes and highlighted the advantages of adopting a post-tensioned approach to large structures. He mentioned the benefits of slender structures and clean installation and reliable phased stressing of a few ‘concentrated’ members rather than a whole range of individual components.

### Finest architectural works

One of the first ‘statement buildings’ was created in Zurich – home to the growing BBR enterprise. The so-called ‘Zur Palme’ skyscraper was inaugurated in 1964 – it stands 50m high and features a cantilevered spiral vehicle access ramp. As Switzerland’s then tallest building, it became the talk-of-the-town, attracting both critics and admirers – everyone had an opinion. Some believe it

is the most significant work carried out by the Haefeli Moser Steiger architectural practice – who won an award for designing this landmark building – and believe that the influences of Frank Lloyd Wright and Mies van der Rohe can clearly be seen. Just a few years later, the Kongresshaus in Biel, Switzerland, was taking shape – with its stunning indoor swimming pool, beneath what was celebrated, at the time, as being Europe’s largest suspended concrete roof. Hailed as the finest work of architect Max Schlup, the conference center was designed to be a symbol of Biel’s modernity. Meanwhile, news of BBR’s post-tensioning technology and its benefits was traveling the world. Curtis & Davis, a New Orleans-based architecture practice of international acclaim were known for their bold modernist designs. They adopted a distinctive sweeping roof line – realized with BBR technology – for the Rivergate Convention Center, one of several major commissions in their home city.

- 1 Kongresshaus, Biel, Switzerland – the dramatically sweeping roof of the indoor swimming pool, adjacent to the Kongresshaus tower, was realized with BBR technology.
- 2 Zur Palme building, Zurich, Switzerland – it was appropriate that local BBR technology should be used for construction of what, at the time of its completion, was the tallest building in Zurich. Photograph © Ikiwaner / Wikimedia Commons / CC-BY-SA-3.0
- 3 Swimming pool, Biel, Switzerland – when completed, the suspended concrete roof, constructed using BBR technology, was celebrated as being the largest of its type in Europe.
- 4 Emirates Office Tower, Dubai – BBR post-tensioning and expertise contributed to the construction of this 54-floor office building.
- 5 Torre Repsol, Madrid, Spain – the BBR Network employed some unusual construction techniques in delivering the vision of project architects Norman Foster & Partners.
- 6 Diagonal Zero Zero, Barcelona, Spain – BBR CONA flat and BBR VT CONA CMI internal post-tensioning systems were chosen for the ribbed beams and reinforced concrete slabs of this iconic building.

### Modern skyscrapers

By 1997, the BBR team was working on the Emirates Office Tower – a 54-floor office building in Dubai. The tower consists of three large core walls which support the load transferred at four levels by large steel trusses, which are connected to the cores with the aid of BBR post tensioning and shear stud connection. At a total height of 354.6m, it became – albeit briefly – the tallest building in Dubai. Together with its sister tower, a hotel complex, the two structures have become symbols of Dubai city.

The focus shifted to Spain in the early 21st century with two stunning towers. First came the 250m high Torre Repsol (or Caja Madrid) Tower, the nation's tallest building, which was designed by Norman Foster & Partners. Some unusual construction solutions were employed in its realization, such as self-climbing systems for the cores, high-rise concrete pumping, movement of extraordinarily heavy metal parts, huge bolted joints, strongly reinforced post-tensioned slabs and heavy-lifting procedures for the building's crown.



5



4

Meanwhile, a short while later in Barcelona, the Diagonal Zero Zero Tower was taking shape. Designed by Catalan architect Enric Massip-Bosch, the supports to this 110m tall diamond-shaped skyscraper consist of only a central core and perimeter columns. BBR CONA flat and BBR VT CONA CMI internal post-tensioning systems were chosen for the ribbed beams and ribbed reinforced concrete slabs.

As mentioned earlier in this special 70th Anniversary review, it all started with the 'Stahltonbrett' – a small prestressed beam. It was targeted at saving precious building materials in the post-war period and, as the technology grew, so did the new opportunities offered to designers. It is clear that architects have continued to embrace BBR technology which has become a regular feature of buildings the world over. ●



6



# CREATING TECHNOLOGY AND TECHNIQUES

In a speech to BBR licensees, after receiving the Freyssinet Medal in 1982 for his contribution to the development of post-tensioning, BBR founder member Max Birkenmaier said that he was firmly convinced that developments in the post-tensioning field were far from complete and that new opportunities could always be found. He also declared BBR's determination to push forward with new developments and this is reflected in many projects, including the strengthening of Tasmania's Catagunya Dam. This was a project which saw the installation of the world's largest ever ground anchors. Although a relatively recent milestone in the BBR Network's portfolio, it reflects BBR's dedication not only to the advancement of knowledge and technology, but also to continuous investment in R&D over the years.

For the Catagunya Dam upgrade project, there were reduced spaces for the permanent ground anchors – thus fewer, but higher capacity, tendons were required. In 2010, the team used BBR VT CONA CMG tendons composed of 91 x 15.7mm strands to achieve a Minimum Breaking Load (MBL) of 25,389kN, test load of 19,415kN and lock-off load of 17,772kN. Travelling back in time, we can see that the BBR ground anchoring technology we know today evolved from early applications, both in Switzerland and Australia.

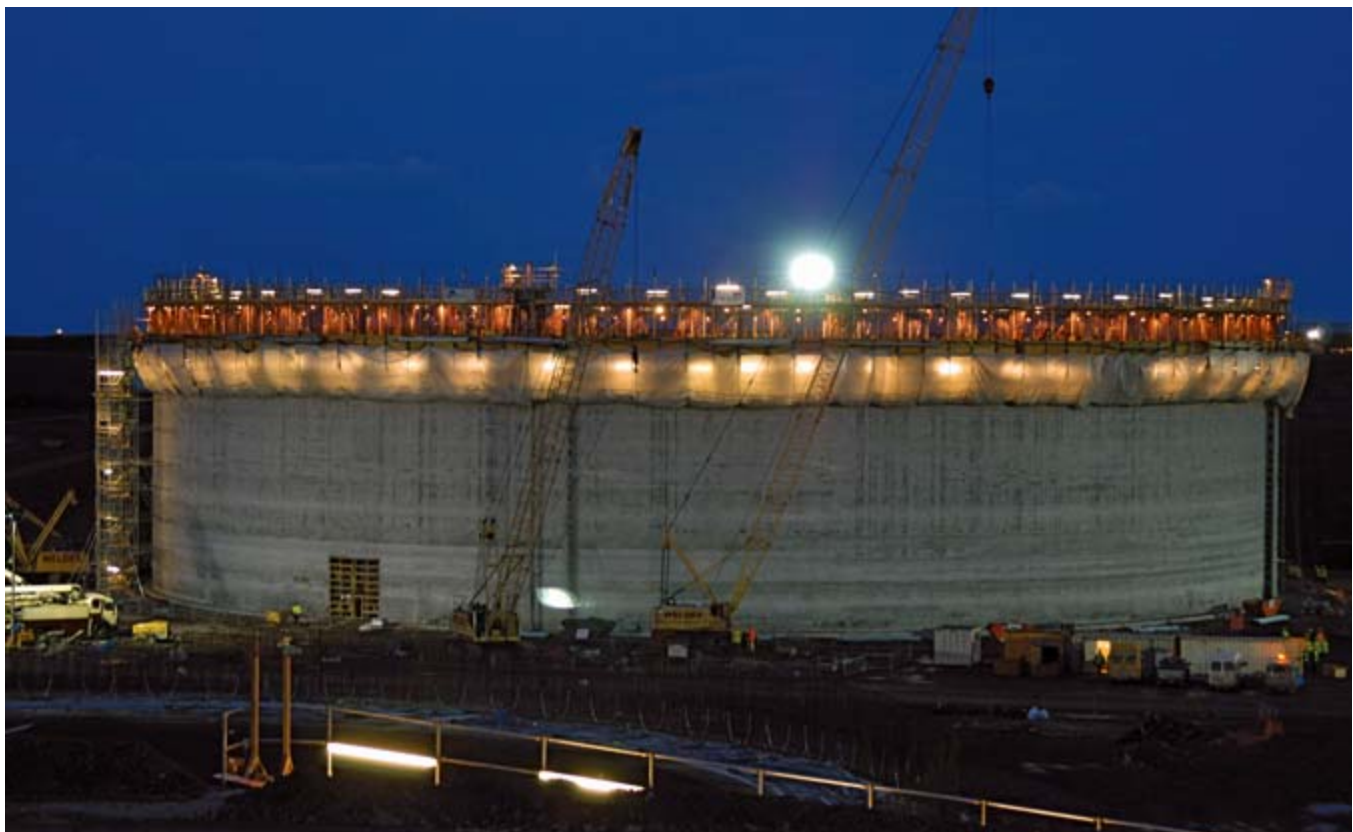



2

### Infrastructure for energy

In the early 1950s, the Maggia Power Station control center at Verbanò was under construction – underground. The rock was poor quality with almost vertical stratification records Max Birkenmaier in his article ‘Prestressed Rock Anchors’, published in the trade magazine Schweizerische Bauzeitung on 21st November 1953. It was decided to secure the concrete wall piles underpinning the vault with prestressed rock anchors to ensure against movement.

“On the mountain side of the wall, a total of nine 40t capacity rock anchors were installed in 19m deep boreholes. On the valley side walls, seven 20t capacity rock anchors were installed to a depth of 12m.” This was clearly a successful operation as two rock anchors were measured six months after the initial stressing and just a 2-3% loss of stress was recorded.

Meanwhile, in New South Wales, Australia, plans were being drawn up for the largest hydroelectric project in the world – the Snowy Mountains Scheme. News of the

new Swiss BBRV prestressed ground anchoring technology had reached Australia and was being evaluated by engineers working on the scheme. The opportunity to take part in this project effectively prompted the foundation of BBR Australia Pty Ltd, the sole BBR licensee for Australia.

Since then, BBR post-tensioning technology has become a vital component of energy and power generation sector construction projects. In the early 1960s, BBR began testing tendons for use in nuclear containment vessels and the technology was applied to 65 power plants around the world. The world market in LNG has required strong, safe cryogenic storage facilities and, again, BBR has been able to supply this – and, in fact, built the world’s largest LNG tank at Darwin, Australia.

The quest to deliver green energy solutions brought wind towers – tall structures with rotors which are firmly anchored in various geological conditions. Installations in Scandinavia and Northern Europe feature BBR ground anchoring technology. ▶



3

## RAILWAY RECONSTRUCTION RESPONSE

In Germany, the state railway authorities began a program of research into concrete railway sleeper development as part of the national reconstruction effort following the Second World War.

Investment in concrete sleepers would deliver a longer service life than wooden or steel sleepers and, ultimately, allowed the German railway network to speed up continuous rail welding.

Bureau BBR collaborated with Augsburg-based Thormann & Stiefel, Inc to devise an economical sleeper manufacturing process which used the BBRV System – thus, the THOSTI-BBRV sleeper was born. It used a prestressing reinforcement consisting of eight 0.272” diameter wires anchored at their ends with BBRV cold-upset heads and anchor plates.

Between 1956 and 1965, some 1.5 million railway sleepers were manufactured for the German Federal Railways using BBRV post-tensioning and contracts for the manufacture of THOSTI-BBRV sleepers under license were agreed with firms in Europe and overseas.



From 1963, THOSTI-BBRV sleepers were also manufactured in Italy under license at SCAC’s purpose-built factory near Rome.

- 1 South Hook, Wales – this LNG reception facility, once the UK’s largest civil engineering project, includes five new LNG tanks realized using BBR technology.
- 2 Wellington Dam, Australia – features ground anchors equal to the world’s largest, installed earlier on Tasmania’s Catagunya Dam.
- 3 Wind towers, Kjøllefjord Wind Farm, Norway – the wind tower foundations have 136 BBR CONA ground anchors.



### Leading edge PT production

As well as road and rail bridges, BBR technology has been used to build tunnels and even airport runways.

Today, motorists travelling to-and-from Montreal probably give no thought to the amazing engineering achievement behind the creation of the Lafontaine Tunnel which has been carrying road traffic beneath the St Lawrence River for almost 50 years. Construction began in 1963 and involved the creation of one of the largest prestressed concrete structures in the world. It was constructed partly as cut-and-cover and partly as immersed tube segments – the latter being constructed in a dry dock, floated out into the river and sunk into position.

Each of the seven 110m precast tunnel segments contains some 88 longitudinal tendons, 240 transverse tendons and 12,233m<sup>3</sup> of concrete.

At that time, this was the largest amount of stressing steel ever to be used on one project.

In his 1965 article for Schweizerische Bauzeitung, Mirko Robin Roš explained: “The need to install a large quantity of prestressing steel – around 6,000t in six months – led to a whole new set of solutions, which would be recognized as the absolute leading edge in terms of PT tendon production and installation.” Meanwhile, Engineering News Record of 1st July 1965 reported:

“Subcontractor BBR of Canada Ltd, Montreal, set up an automated plant near the site to fabricate as many as 100 prestressing tendons per day in lengths of 36.5m to 91.5m.”

The most important part – a section of side wall and tunnel floor – was built on Stahlton’s factory test site. From this exercise, not every detail of the project’s stressing execution could be trialled, but useful advice could be won.

Infrastructure improvements of a different kind were afoot in New York. The two runways of the city’s La Guardia Airport were being given 300m and 600m extensions – making them both 2,100m long – to enable the airport to handle jet aircraft. With major highways and dense urban development encircling the airport, the only option was to extend the runways into Flushing Bay – even though this meant digging a new channel for shipping in the bay and raising the east-west runway by around 30cm.



4



5



6

Tidal flow ruled out a landfill solution, therefore the new extensions were supported by a grid of around 3,000 piles. After the piles had been driven, ‘I’ beams were installed longitudinally and double ‘T’ beams were fixed, transversally, on top of these.

On site, there were five 110m long casting beds for prefabricating the prestressed ‘I’ and double ‘T’ beams. Frames containing up to 24 reels of prefabricated BBR tendons stood at the end of each casting bed, the reels were laid on a turntable and the tendons were installed directly into the beam. Stressing of the 3,000 ‘I’ beams and 13,000 double ‘T’ beams was carried out in three stages. A total of 120,000m<sup>3</sup> of concrete was used, plus around 3,500t of prestressing steel was needed for the BBRV tendons.

- 4 Lafontaine Tunnel – view of a segment in the dry dock. The tunnel’s four walls enclose a pair of 40ft wide roadways and a 23ft wide service and ventilation area in the center.
- 5 Lafontaine Tunnel – aerial view of the building site and dry dock beside the Columbia River in late summer 1964. On the right, are the entrance ramps under construction and on the left, the seven prestressed concrete segments which would later be floated into position and submerged.
- 6 La Guardia Airport Runway Extension – prestressed ‘I’ beams installed on top of the piles.
- 7 Cormorant A oil production platform – 266 x 375t capacity BBR post-tensioning tendons were installed in the four towers during slipforming.
- 8 Monaco harbor extension – the 350m long floating breakwater for extending the principality’s harbor is being towed into position.
- 9 Isola di Porto Levante – the floating LNG terminal was constructed in a dry dock in southern Spain, then towed into position in the Adriatic Sea.

### Floating structures

Jumping forward to the 1980s and then onto the 21st century, it becomes clear that BBR technology and expertise has continued to rise to the challenges of evolving market needs.

In 1979, construction of the Cormorant A oil production platform required post-tensioning for four slipformed towers. A total of 256 x 375t capacity tendons were installed and anchored in the towers while they were being slipformed. As well as the technical challenges, the team had a tight deadline and inclement weather conditions to overcome.



7



8



9

A quarter of a century later, two further floating structures were under construction – the new floating ‘breakwater’ that was to become an extension to Monaco’s busy La Condamine Port and the Isola di Porto Levante, a floating LNG terminal now moored in the Northern Adriatic. Both were constructed in a dry dock in Algeciras, Spain and later floated into position. Monaco’s 350m long floating breakwater was recognized in the 2006 *fib* Awards as an ‘outstanding concrete structure’. BBR technology and know-how has continually grown over the decades, evolving with the ever more demanding needs of an increasingly sophisticated and environmentally aware market place. Our engineers are ready and looking forward to the challenges of the next seventy years. ●



# VIRTUAL GOES REALITY

It has always been the BBR philosophy and culture to explore and adopt the very latest methods to extend and improve the service offered to the market place. Marcel Poser, Chairman of BBR VT International Ltd, explores where technology could take us next.

Within the Tectus Group, parent company of BBR Holding Ltd (one of the shareholders of BBR VT International), we are now creating a center of excellence focused on latest technology.

Very recent work towards the development of the so-called Augmented Virtual Object Assessment, has shown how, for example, non-destructive testing, visits to the doctor's office and many more applications can make use of cloud technology to accurately deliver 'Big Data' in an end-user friendly form.

If this all seems far-fetched for the construction industry, just remember that when the first piece of BBR construction technology was produced seven decades ago, the idea of broad scale use of post-tensioning was considered novel – yet today, the benefits are well understood and it has become commonly used. Along the way, specialist BBR services, technology and ways of doing business have also been developed and successfully applied – many of which would have seemed futuristic when they were introduced.

The digital age is progressively making in-roads into every aspect of our world and the 4th industrial revolution is upon us – 'cyber-physical production systems'. In the construction sector for example, BIM – Building Information Modeling – is really starting to take off, with governments making its use mandatory.



## Virtual benefits become real

Typically, BIM produces a fully specified 3D virtual model of the structure, taking it from the basic structure – and to a level of detail which can even show where finally the plug sockets will be in the completed building! Actually, what this practice leads to is cost-efficiency – being able to do so much in advance in a virtual space – construction can proceed faster, with less flaws and more according to schedule. Unlike flat, 2D drawings which become consigned to a filing drawer or archive, this virtual model brings greater efficiency and effectiveness to the longer term operation and maintenance of the structure too.

“The digital age is progressively making in-roads into every aspect of our world and the 4th industrial revolution is upon us – 'cyber-physical production systems'.”

#### **Next step**

Down the line, we'll be seeing a full 3D approach to a project – before it goes into the construction phase – and modeling its entire constructability to optimize towards responsible usage of spare resources and materials and enhance productivity and safety at work at the same time. It is hoped that construction can take place in a safer way – through the integration of health and safety aspects into the construction modeling and the execution.

We will see traditional H2H (human-to-human) blending in seamlessly with M2M (machine-to-machine) and H2M (human-to-machine) communication and interoperability during the execution of projects. Machines telling humans what we can do better, where we can be more efficient, where we are moving towards unsafe practices, there will be smart algorithms towards predictive construction and there will be a tremendous push towards efficiency. Traditional professions will be replaced by machines, such as drones, robots and software applications, which can operate faster, longer, safer and more efficiently. It will not stop there, once completed, we will have smart structural elements and fittings equipped with built-in intelligence, with information flowing back into virtual models of the structure to continuously enhance the usage of a structure and the comfort level of its users. It's not just about structural integrity, but also the facility to control buildings in an intelligent way and in a way that a building can learn – when should the air conditioning be turned off, when should humans or traffic be rerouted to allow for an efficient usage of the building, conserve energy and so forth. ➤





“Our know-how and our business reflexes coming out of these new activities will also put completely new perspectives on the construction space and our activities in this domain.”

#### **Challenge to deliverables**

There needs to be a new technological challenge on deliverables – not just classic hardware, but digital componentry and most importantly completely new business models and approaches.

At Tectus, we are already at the forefront of many of the new innovations, with sound activities and innovation in smart devices-and-solutions for the traditional bricks-and-mortar industry – and also for new enhanced materials, consumer devices and medical applications. We are active in virtual reality – screening and documenting an activity... be it a sports event, a medical intervention, construction works or inspection on site not by means of traditional cameras, but by virtualizing content and – if so wished – streaming it live in a virtual reality environment... the boundaries of real and virtual will be indistinguishable. Our know-how and our business reflexes coming out of these new activities will also put completely new perspectives on the construction space and our activities in this domain.

A word of caution here – we must be realistic and differentiate between the creation of ‘just another gadget’ and something that really adds value to the situation – we need a true value proposition for all and everything that we do.

#### **Return on investment**

When you are making an investment of several hundred million dollars in developing buildings and infrastructure, why would you not want to have a full digital representation of everything that went into your asset? The complete integration of virtual reality into construction is the logical way of doing it. Taking this a step further, it leads to the enabling of interaction between users and the building – like you see in some of the science fiction movies. It opens up a wide range of new business activities, not directly related to the technology that BBR currently provides, but which improve the overall value to construction workers, developers, owners and users.

#### **Global movements delivered locally**

You need a certain critical size and worldwide reach to justify the investment required to embrace this new technology – and you need to have the scope to deploy it on the world market. At BBR, we have both factors – BBR Network Members in 50+ countries worldwide, plus the financial and other resources via its shareholders. Members of the BBR Network are independent local entities and might not be able to justify creating such technology themselves, however, it becomes viable by sharing the costs around the globe through a franchised network such as ours. The advantages are in being small and local, yet still being able to benefit from global trends. You can expect to hear more about the initiatives underway at Tectus in the near future. Meanwhile, BBR Network Members should remain alert to emerging ideas, services and products within their individual markets, as we jointly have the capacity to make new approaches and technologies work for us and, together, we can achieve worldwide distribution.

One thing’s for sure, BBR’s three founders – engineers of great vision and intellect – would without doubt be taking the same steps that we, their successors, are taking. They would also be networking and collaborating with the leading thinkers and players to produce the ultimately practical, well-engineered and master-minded solution for the next decades. ●









## The Global BBR Network

### Abu Dhabi

Structural Systems Middle East LLC

### Australia

Structural Systems Pty Ltd

### Austria

KB Vorspann-Technik GmbH

### Bahrain

NASA Structural Systems LLC

### Belgium

Spanstaal – Ballast Nedam Infra  
Specialiteiten B.V.

### Bosnia / Herzegovina

BBR Adria d.o.o.

### Bulgaria

BBR Pretensados y Técnicas Especiales, S.L.

### Canada

Canadian bbr Inc.

### Croatia

BBR Adria d.o.o.

### Denmark

KB Spennteknikk AS

### Dubai

NASA Structural Systems LLC

### Estonia

KB Vorspann-Technik GmbH

### Fiji

BBR Contech

### Finland

KB Spennteknikk AS

### France

ETIC S.A.S.

### Germany

KB Vorspann-Technik GmbH

### Ireland

Structural Systems (UK) Ltd

### Jordan

Marwan Alkurdi & Partners Co. Ltd

### Kingdom of Saudi Arabia

Huta-Hegerfeld Saudia Ltd

### Kosovo

BBR Adria d.o.o.

### Kuwait

Marwan Alkurdi & Partners Co. Ltd

### Latvia

KB Vorspann-Technik GmbH

### Lesotho

Structural Systems (Africa)

### Liechtenstein

Stahlton AG

### Lithuania

KB Vorspann-Technik GmbH

### Malaysia

BBR Construction Systems (M) Sdn Bhd

### Montenegro

BBR Adria d.o.o.

### Netherlands

Spanstaal – Ballast Nedam Infra  
Specialiteiten B.V.

### New Zealand

BBR Contech

### Norway

KB Spennteknikk AS

### Oman

Structural Systems Limited (Oman Branch)

### Philippines

BBR Philippines Corporation

### Poland

BBR Polska Sp. z o.o.

### Portugal

BBR Pretensados y Técnicas Especiales, S.L.

### Qatar

NASA Structural Systems LLC

### Romania

BBR Pretensados y Técnicas Especiales, S.L.

### Russia

KB Vorspann-Technik GmbH

### Serbia

BBR Adria d.o.o.

### Sharjah

Emirates & Australia Const. Systems LLC

### Singapore

BBR Construction Systems Pte Ltd

### Slovenia

BBR Adria d.o.o.

### South Africa

Structural Systems (Africa)

### Spain

BBR Pretensados y Técnicas Especiales, S.L.

### Swaziland

Structural Systems (Africa)

### Sweden

Spännteknik AB

### Switzerland

Stahlton AG

### Syria

Marwan Alkurdi & Partners Co. Ltd

### Thailand

BBR Construction Systems Pte Ltd

### Ukraine

BBR Polska Sp. z o.o.

### United Kingdom

Structural Systems (UK) Ltd

### Vietnam

BBR Construction Systems Pte Ltd